

Cor Lulof  
2003

**SQUEEZE that trigger! Don't JERK!!!!**

**NOTES ON A4 / V2  
STATE OF THE ART**



## **Introduction**

This is a compilation of notes I made, triggered by discussions in the E-mail forum of the International V2 Research Group. As my administrative skills are a little bit retarded, they were dispersed over all dark corners of my harddisk. Now they are just dumped together in this file, so don't expect a complete coherent story! If somebody wants to use parts of it: be my guest!

Borne, May. 19, 03

Cor Lulof.

## Aiming an A4

Later in this booklet you will find two articles on Brennschluss and Leitstrahl, describing the technical functions, but not explaining where the input parameters came from. This chapter will try to give an answer.

To launch a ballistic missile from point A to point B two very important things have to be known: the required speed and direction. The speed is dependent from the distance between A and B. That's easy, isn't it? One takes a map, measures direction and distance and that's it!

Not quite.... There are two hairs in the soup:

- Either the distance or the direction (or both) on the map are wrong!
- During the time of flight the target travels to the East as a result of earth rotation.

Let's discuss those problems first, as a basis for the actual A4 aiming procedure.

### About Maps

The earth is a sphere. (More about that later!) A map is a representation of a part of that sphere on a flat piece of paper. But an exact representation of a piece of a sphere on a flat piece of paper is totally impossible! A small area on that sphere approximates a flat plane, more or less, but for greater areas the representation is incorrect. The surface of a sphere can only be represented by a sphere. If you need a scale 1 : 25000 topographic map, you have to carry a globe with a diameter of more than 500 meters, which is hardly practical. So mankind invented lots of projection methods to paint the earth surface on a flat piece of paper. All those methods are based upon a virtual point in the centre of the earth. A line from this point through Paris, intersects a piece of paper and at the point of that intersection Paris is drawn on that piece of paper. That piece of paper may be flat and touching or intersecting the earth surface, or it may be rolled to a cylinder or a cone, also intersecting or touching the earth surface. Usually (but not necessarily) the axis of the cone or cylinder coincides with the earth axis.

There are projection methods that give a true impression of the *surface* of objects, the *distance* between objects or the *direction* in which objects are located, but there are no projection systems giving a true impression of more than one of those properties.

The shortest way from point A to point B is called a "great-circle". Winnipeg lies almost exactly West of Amsterdam. If you look to a globe from a point on a plane through Winnipeg, Amsterdam and the centre of the earth, you see a straight line.

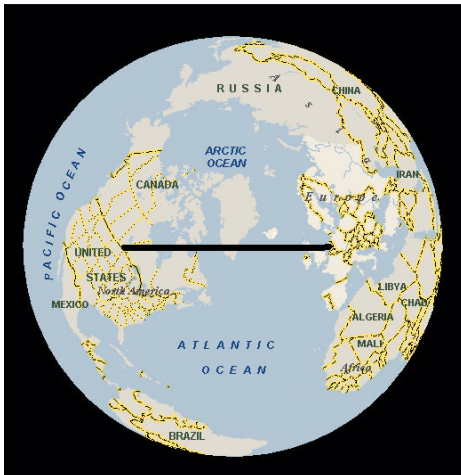

Exactly the same route, projected on a map, shows a curve. Observe that on the map



Winnipeg lies West of Amsterdam, and Greenland is not lying between Amsterdam and Winnipeg, but your A4 has to be launched in Northwestern direction and flies over Greenland to reach Winnipeg. But things will even get worse!

We assumed that the earth is a sphere, but it isn't. Due to centrifugal forces, caused by earth rotation, the earth diameter measured over the poles is less than as measured over the equator. So to make things complicated, some map projections are based upon a spherical earth, some on an ellipsoid earth. And to complete the disaster, not all map-makers handle the same ellipsoid. There are ellipsoids of Lambert, Gauss-Kruger, Bessel, Clarke .....

The Germans had maps of England, with geographical coordinates (Degrees, minutes, seconds) based upon the ellipsoid of Airy, and French maps with Lambert I projection, grid Zone Nord for their launching sites in Northern France and Belgium, based upon the ellipsoid of Clarke. The Dutch maps were in (spherical) stereographic projection, projected on a flat plane, intersecting the earth surface in such a way that the intersection forms a circle with a radius of 122 km round the O.L.V. church at Amersfoort, being the origin of the coordinate system at that time. The grid was a rectangular 1 km x 1 km grid. And computers did not yet exist!

### About earth rotation

As the earth rotates, a point on the equator travels a distance of 40000 km per 24 hours, so the speed on the equator is  $40000 / 24 = 1666.66667 \text{ km/h} = 27.77778 \text{ km/min}$ .

London lies  $51.5^\circ$  North of the equator, so London travels east with a speed of  $27.77778 \cdot \cos(51,5) = 17,29 \text{ km/min}$ , because the radius of the circle is smaller there.

That is no problem if the launching position has the same speed. The Hague lies  $52.1^\circ$  North of the equator and has a speed of  $27.77778 \cdot \cos(52,1) = 17.06 \text{ km/min}$ .

London moves  $0,23 \text{ km/min}$  faster to the East than The Hague, so during the time of flight (5 minutes) London moves  $5 \cdot 0.23 = 1.15 \text{ km}$  East with respect to the launching position.

So the rocket has to be aimed at a point  $1.15 \text{ km}$  East of the target. And that's not the only correction, the launching (Brennschluss) speed must also be corrected, because the horizontal rocket trajectory is shorter than the distance from the Hague to London.

Did the Germans really apply all those corrections? To obtain a circular error probability of many miles? Yes, they did, but remember: the A4 they used was the result of a premature and primitive production; the A4 design was based upon a requirement of 250 m CEP, to be obtained with a stable platform navigation system, and the production A4's were fitted with the "Horizont" and "Vertikant" gyro's instead, an emergency solution, according to the Peenemünde team.

Within the "Batterie-Trupp" the "Rechen- und Auswerte-Trupp" had the task of calculating the proper values and issuing the launch-order. The "Vermessungs-Trupp" had to fixate all positions for launch-tables, BS and LS-antenna's etc.

The following is mainly based upon the "A4 Lehrbuch" and the "A4 Fibel"

### Launch preparations

The basic tasks of the geodetic team are:

- Position fixation
- Calculation of the parameters and issuing of the launch-order
- Position marking within launch-site and auxiliary sites
- Aim the rocket in azimuth

The long range requires high accuracy. The shot requires an accuracy of 1 mil. (1 mil is ~1 meter error at a range of 1000 meters. It roughly equals 1 milli-radian.  $360^\circ = 6400 \text{ mils}$ )

To fulfill this requirement the accuracy of the measurement of geodetic parameters must be better than 0.1 mil. That requires tools like theodolites and basic optical ruler beams.

1. Position fixes. Purpose: fixation of aiming points with known coordinates in the grid of the launching area. Standard geodetic procedures (triangulation) are used. To eliminate errors,

multiple measurements are made. The following equipment is available: theodolite TH40 (Zeiss), standard optical ruler, 2 m, steel ribbon-rulers, 20 m and 100 m length.

## 2. Calculation of the parameters and issuing of the launch-order.

### a. General

In deployment of the A4 neither direct aiming nor impact observation is possible. Direct aiming is prohibited by the relevant range, and correction after impact observation is hardly applicable because only very few shots are launched from one position. That limits the possibilities to calculated fire only.

The aiming parameters however cannot be obtained from a map. If the map would cover launch position and target, the scale would be such that it is inaccurate. If a map with sufficient accuracy is used, the scale is such that launch-position and target are not on the same sheet. Even if the map containing the launch position and the map containing the target could be placed in the proper relative position, the parameters could not be used because the earth curvature must be taken into account, which results in a curved trajectory.

So the launch parameters may only be calculated from the target- and launch-position coordinates. Launch position coordinates are obtained by geodetic methods and target coordinates are obtained from a map or a list.

### b. Maps

For the launch positions in Northern France and Belgium maps in the Projection Lambert I, Zone Nord, with grid Lambert I, Zone Nord, are available.

The Lambert projection is a cone-projection with a cone-axis coincident with the earth-axis. Originally touching the earth surface in a parallel circle in the centre of the map zone, it was modified to an intersecting cone, intersecting the earth surface in two parallel circles, at equal distances of the original centre circle. If the cone is unrolled, the two intersection lines show as circular curves on the map, with the top of the cone as centre. The meridians originate at the top of the cone and show as diverging straight lines. In the projection the intersection circles have the proper length. For the Zone Nord the central parallel circle lies at 55° North, the two intersection circles at 54° and 56° North. Projection is based on the Clarke ellipsoid.

The Lambert I grid is a rectangular grid. The intersection of the Paris meridian and the central parallel circle has the coordinates X = 600 km, Y = 200 km.

For the target areas in middle and South England, maps are available, giving geographical coordinates, and based upon the Airy ellipsoid.

All calculations are based on the Clarke ellipsoid, so all target coordinates have to be converted to that system.

### c. The calculation

First the distance and direction of the line between launch position and target is calculated. As the earth curvature must be taken into account, this is not a straight line, but the shortest connection over the earth surface. If the earth is approximated as a sphere, the connection line is a great-circle. If the earth is approximated as a rotation-ellipsoid, the connection line is a higher order curve, a geodetic line, in this case a loxodrome. Like the great-circle, the loxodrome intersects the meridians under different angles. On usual maps the loxodrome shows normally as a curved line. The result of this calculation, the length of the loxodrome and its bearing at the launch position, are called "Approximate Bearing" (AB) and "Approximate Range" (AR).

For the A4 ranges, the change of the ground projection of the flight trajectory due to earth rotation already plays a role. It causes a shift of the impact point in range and bearing. The bearing error is, on the Northern hemisphere, to the right, the impact point lies shorter with a shot to the East, a shot to the West overshoots the target. These errors are eliminated by corrections of the AB and AR and result into the "Final Bearing" (FB) and the "Final Range" (FR).

Basis for the calculations is the "Merkblatt für die Vermessung der z.b.V.-Stellungen" and the tables-booklet belonging to it. At some points these books are obsolete. (1944!) The calculations are performed on pre-printed forms.

#### Calculation of the approximate range and bearing.

First preprinted form 5 is used to convert the geographical coordinates of the target to the ellipsoid of Clarke. Now the coordinates of launch position and target are both based on the same ellipsoid. The calculation is performed in both geographical coordinates and grid coordinates.

To accommodate the calculations in geographical coordinates, now the coordinates of the launch position (if they are grid coordinates) are converted to geographical coordinates, using preprinted form 1.

From the geographical coordinates of target and launch position the AB and AR are calculated, using two different methods.

The first procedure is a coefficient method, described on preprint form 2. The principle of this procedure is not transparent and will not be commented here.

The second method uses preprint form 3 and is based on a spherical triangle. The coordinates, based on the Clarke ellipsoid are transformed to a sphere and, using spherical trigonometry, length and direction of the connecting great-circle are calculated. The results are converted back to the ellipsoid.

The calculation in grid-coordinates is simple. As the diverging of the grid over great distances introduces errors, corrections are applied. Using preprint form 1 the geographical target-coordinates, already converted to the Clarke ellipsoid, and the launch position coordinates, if geographical, are converted to the Lambert I Zone Nord grid. Then range and bearing are calculated in the usual way. After that, preprint form 4 is used to calculate range- and bearing-reduction for the Lambert-projection.

The results of the calculations are collected on a special form and weighed and averaged for further processing.

#### Establishing the final range and bearing

The AR and AB are corrected for earth rotation. The corrections are dependent from the geographical latitude and the direction of the shot. The corrections are read from "Graphical presentations 6". The tables are valid for different latitudes. The applicable table is selected by averaging the latitudes of target and launch position. An interpolation between two tables to the exact latitude is omitted. The corrections for earth rotation are introduced in the calculations on the special form, mentioned before. The results are the final range and the final bearing.

#### Editing the launch order.

The final range is corrected just before launch, according to the ballistic table, for missile weight. The actually fuelled weight of B-Stoff is inserted and the A-Stoff weight at launch, calculated from elapsed time and evaporation loss rate. The missile range is solely

dictated by the moment of Brennschluss. It is calculated, taking the ballistic table value, distance to the BS position and its offset from the target line into account. Adjustment values, based on the ordered frequency, are issued to the BS position. The final bearing is issued without corrections.

### 3. Position marking within launch-site and auxiliary sites

The central point A of the launch site, basis for the calculations, is located in the middle of the projected launch positions in the launch site, if possible.

The launch positions have to be at least 30 m apart, the maximum distances are limited to 50 or 60 meters, dependent from the available cables. The relative positions of the launch-platforms are not important.

Nearby, preferably not more than 100 meters away, the auxiliary point R1 is fixated. Its purpose is: aiming the rocket. If necessary a second auxiliary point may be fixated to control the point R1.

#### Brennschluss position. (see page 10)

The central point B of the Brennschluss position must be located 12 km behind point A, on the calculated final bearing line. If there is no way of locating the BS position there, the distance between A and B may be reduced to a minimum of 8 km. Its coordinates are calculated in grid coordinates in the level plane. Corrections in distance and bearing are not necessary.

Around point B a circle with a radius of 500 m must be free of trees. In this circle the rhombic antennas must be positioned, each one in a 100 x 100 m square, tilted less than 5° in any direction. The centers of these squares (the antennas) must be 250 – 500 m apart and one of their diagonals must be pointing approximately in the launch direction and the connection line between their centers must intersect the target line under an angle of approximately 45°.

Direct sight must be possible between a point 3 m over point B and a point 600 m over point A.

At a BS position 12 km behind the launch position the height of the horizon coverage must not exceed 50 mils.

#### Leitstrahl position (see page 11)

The central point L of the Leitstrahl position must be located 10 – 16 km behind point A in the launch site and exactly on the line through A in the final bearing direction. The coordinates are calculated with the grid coordinates in the horizontal plane and bearing- and distance-corrections are applied. Around the central point L a rectangle is required, stretching 300 m to both sides, 500 m to the front and 300 m to the rear, free of buildings, trees, wire fences and telephone or power lines. The maximum difference in height is 1 m. 100 m to the left and to the right of central point L both dipole antennas are placed. The line connecting the two antennas must be perpendicular to the line A – L. Around both antennas a circle with a radius of 30 m must be horizontal. Inside these circles triangles with equal sides must be situated, the top at the antenna foot, the baseline perpendicular to the direction of the shot. These triangles should be flat, level and homogeneous.

Direct sight must be possible between a point 3 m over point L and a point 25 m over the Leitstrahl test receiver, located on the final bearing line, 80 – 500 m before or behind the central point A.

#### Marking and the site log.

To enable finding the site at a later time, some points are marked:

At the launch site:

- The launch positions and the auxiliary point R1
- For Leitstrahl shots the position of the Leitstrahl test receiver
- 

At the Brennschluss site:

- The central point B and the antenna positions i.c. the middle of the squares
- 

At the Leitstrahl site:

- The central point L
- The antenna positions, i.c. the centre of the circles / top of the triangles.



The marks and the additional information where to find them, are noted in the site log. The log contains further information, not concerning site geometrics.

#### 4. Aiming the A4 rocket

##### a. Setting the site into operation

First the marked positions have to be found and checked against the site log.

Then all relevant equipment such as launch platforms, antennas for Brennschluss and Leitstrahl and the Leitstrahl test set are directed to the marked positions. At the Brennschluss site the direction of the shot must be indicated, to enable proper setup of the antennas.

##### b. Setting the A4 rocket plumb.

For the test of the controls the A4 rocket has to be set exactly plumb. Two collimators 12m are used for that purpose. One is positioned on, or close to, the target line, the other one on a line perpendicular to the target line, both at a distance of approx. 50 m.. The tail connection ring is set exactly in the centre of the telescope scale.

Then the nose of the rocket is observed, without changing the telescope bearing. The launching table legs are readjusted until the rocket nose is exactly on the centre line of both collimators.

The procedure is repeated twice and after that checked again.

##### c. Aiming the rocket.

It is important that the gyro-axis of the "Vertikant" is exactly perpendicular to the final bearing line and that the rocket itself stands exactly plumb.

To adjust the "Vertikant", its attitude is compared with the jet-rudder 1 and 3 axis. For some rockets the perpendicularity of "Vertikant" gyro-axis and jet-rudder axis 1-3 is factory adjusted. If not, the error-angle has to be measured. For that purpose a dial sight is attached to the "Vertikant" frame by means of a special fixture and a second dial sight is attached to the jet-rudder shafts 1, 2 and 4, by means of a different special fixture. The fixtures are constructed in such a way that the "Vertikant" sight, if set to 6400 mils, is exactly perpendicular to the gyro axis. The jet-rudder dial sight is exactly parallel to jet rudder axis 1 – 3, if set to 6400 mils. Both dial sights are set to observe the same distant aiming point. If the distance to the aiming point is 1000 m or more, the difference between the readings of both dial sights is sufficiently accurate to use it as error-angle. If the distance to the aiming point is less than 1000 m, the angle between both dial sights is measured by means of a theodolite at the aiming point and added to or subtracted from the angular error as measured with the dial sights.

The rocket comes in three different versions.

1. The "Vertikant" is mounted in a fixed frame, so the angular error has to be measured and taken into account, aiming the rocket. The measured value is written on tailfin 1.
2. The "Vertikant" is mounted in an adjustable frame, so the angular error may be adjusted to zero.
3. The angular error is factory-adjusted to zero and checking is not required.

To aim the A4, the dial sight on the rudder axis is used. By means of a 12m dial-collimator the rocket is rotated until the jet-rudder dial sight is in the final bearing (FB) direction, taking the angular error into account.

After that, the rocket plumb is checked again.

#### **Setting the rocket in FB direction**

The collimators used to align the A4 were constructed as follows:

- A tripod with a base plate.
- A ring that may rotate on that base. (Ring 1)
- On top of that: a second ring that may rotate with respect to Ring 1.(Ring 2)
- On top of Ring 2, and fixed to it, an elevation jug with a telescope.

The angle of rotation between Ring 1 and Ring 2 may be read from an accurate scale. Ring 1 and Ring 2 are locked together by a spring loaded device, so they rotate together with respect to the base plate. Locking is achieved by a "pin in hole" device ("ratchet") , so an accurate lock is only possible at defined small angular intervals. To allow interpolation between those intervals, the telescope has a

horizontal scale bar. The telescope has, in the lower side of its field of view, an optical device to read the locked values of the angle between Ring 1 and Ring 2.

So:

- Normally Ring 1 and Ring 2 rotate together on the base plate.
- If the “Locking button” is pressed, the lock between Ring 1 and Ring 2 is released and Ring 2 rotates with respect to Ring 1.

The A4 alignment procedure.

A collimator is placed at position 1. Position 1 is fixed by the “Vermessungstruppe” and can be found in the site log. It is also marked in the terrain. From Position 1 at least one characteristic landmark at a greater distance is visible. (The church tower in Village A in the A4-Fibel.) Furthermore the site log gives the angle between that landmark and the target direction (Angle  $\alpha_1$  in the figure).

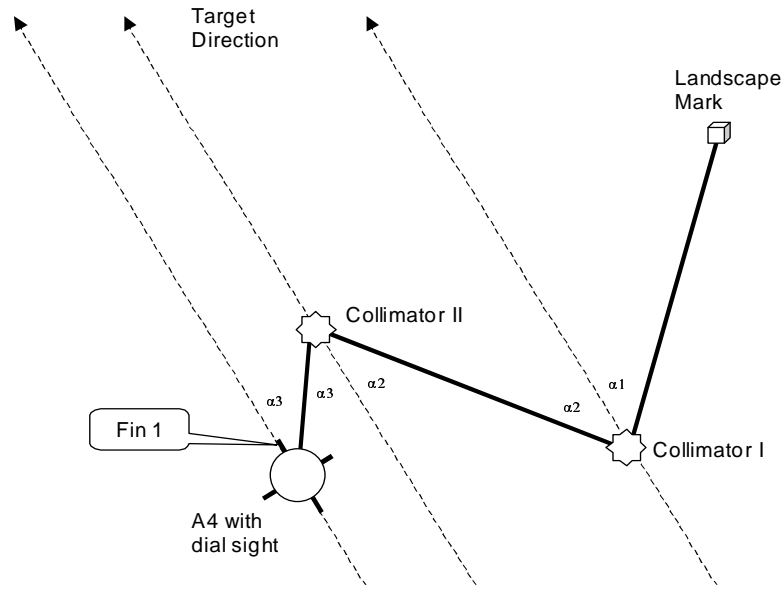

The man at Position 1 places and levels his collimator and adjusts the angle between Ring 1 and Ring 2 to  $\alpha_1$ . Then he aims the collimator telescope at the landmark. As the angle between landmark and target equals the angle between Ring 1 and Ring 2, the zero mark of Ring 1 now points exactly to the target.

The operator now pushes the button to unlock Ring 1 and Ring 2 and turns the telescope (plus Ring 2) until the collimator at Position 2 is in his cross wires. Now he releases the button and reads and notes the new angle between Ring 2 and Ring 1. Ring 1 did not rotate, so its zero line is still pointing to the target! That new angle is  $\alpha_2$  in the figure.

The man at Position 1 now communicates this angle to his “comrade” at Position 2.

At Position 2 the operator adjusts the angle between Ring 1 and Ring 2 to this value ( $\alpha_2$ ). Then he aims his telescope at the Position 1 collimator. Now *his* Ring 1 is aligned with the target line. He unlocks Ring 1 and Ring 2 and turns his telescope to see the dial sight under the A4. He releases the lock button and reads the new angle between Ring 1 and Ring 2. In the figure the angle  $\alpha_3$ . He notes the value of  $\alpha_3$  and communicates it to the third “comrade”, the one at the A4.

Under the A4, in a removable fixture, attached to graphite rudder shafts 1, 2 and 4, hangs a dial sight with (again) a base ring with an accurate angular scale. Zero angle is the exact direction of fin 1. The A4 operator gets the value of  $\alpha_3$  from operator 2 and adds a correction angle to that value. That correction angle value (positive or negative) differs per rocket and may be read from the air rudder of fin 4. Now the A4 operator signals the ground crew to rotate the A4. The A4 is rotated until

the  $\alpha_3$  value of the dial sight scale coincides with collimator 2. Tailfin 1 of the A4 now points exactly to the target (if we assume that the rocket correction angle is zero!)  
 In real life the Germans used an even fancier trick: the angle  $\alpha_3$  was not obtained from operator 2, but read directly from collimator II, through the dial sight.

The collimator rings are divided in Mils. 6400 Mils = 360 degrees. The locking device locks every 100 Mils. In the telescope there is a fine division to interpolate between clicks. There are always two adjacent 100-Mil-positions readable in the telescope window, for example "22 23". The fine scale in the telescope ranges from 40 to 100 Mils on the left side of the vertical cross wire and from 0 to 60 Mils on the right side. If the course window reads 22 23 and an object is seen 33.5 Mils right of the vertical cross wire line, the reading is 2333.5 Mils. If an object coincides with the 77 scale-line left of the vertical cross wire line, the reading is 2277 Mils. An error of 1 Mil approximately equals an error of 1 m at a distance of 1 km. If the total inaccuracy in lining up the A4 is 1 or 2 Mils, the error at a range of 300 km is only 300 or 600 m.

This alignment procedure, clumsy as it may seem, gives only a negligible contribution to the overall system CEP!

It may be clear by now that the first collimator establishes the target line and that the second collimator only repeats it. Dependent on the terrain condition the second collimator may be omitted (Backfire!) or a third one may be introduced. Only the first collimator has to be positioned exactly over the position mark, using a plumb line, the position of the other one(s) is arbitrary, the last one must be within 12 m of the A4, to make its scale readable from the dial sight.

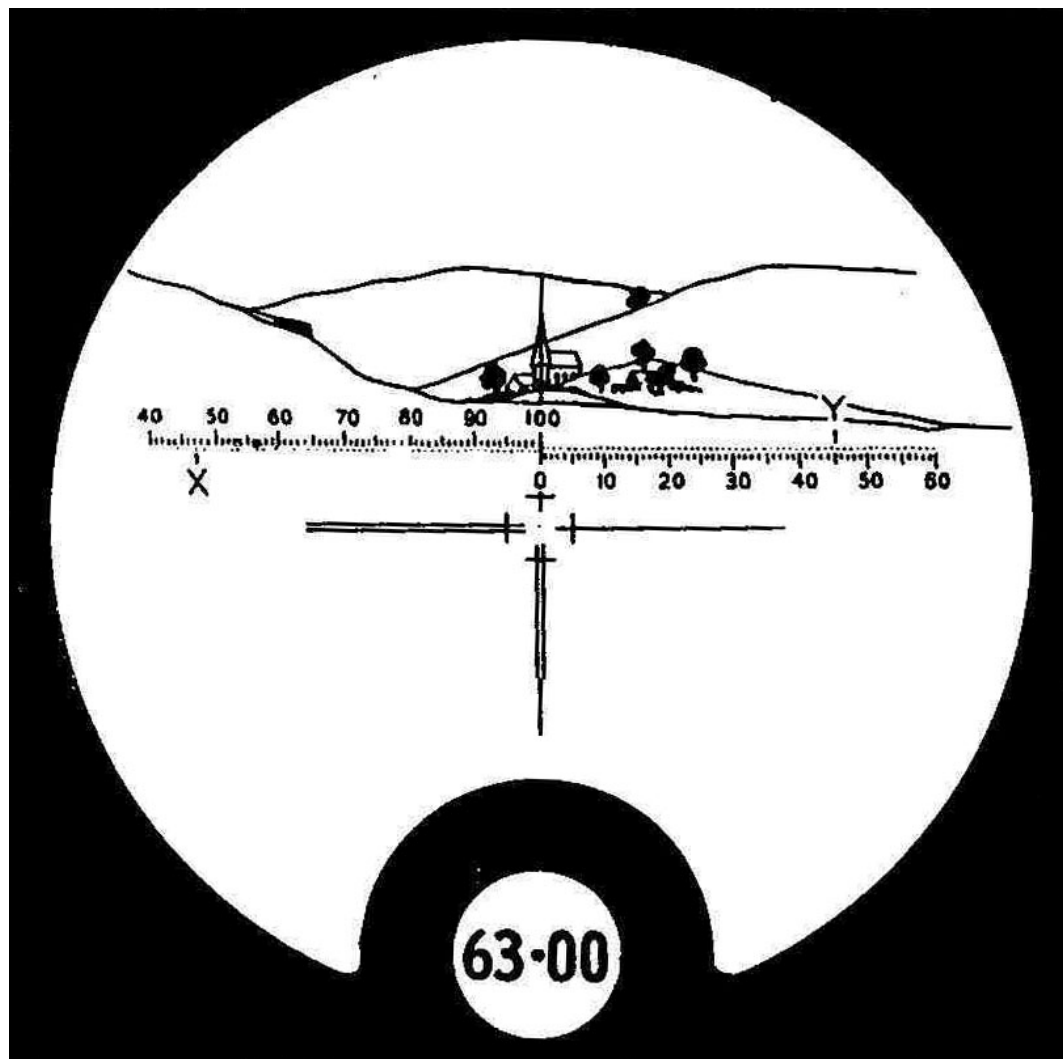

The church tower is at 0 mils (or 6400, which is the same).

Point X is at 6347.5 mils and point Y reads 45 mils. The round lower scale reads multiples of 100 mils. If the reference point is on the left side of the vertical crosswire (like X), then you read the left figure in the lower round window. I.e.: 63 (6300 mils) and add the upper scale value (47.5) to it. The result is 6347.5 mils.

So the angle between the church tower and point X is 6347,5 mils, if you measure the angle to the right (clockwise), which is the standard way.

The site log tells you the angle between the targetline and a visible landmark. Suppose it is 4545 mils.

You set the ring for the lower window to read 44.45. Then you position the 45 mils mark of the upper scale over the landmark.

**The zero mark on the ring is now pointing exactly to the target!**

Now you turn the collimator head to view the center of the next collimator. The angle you read now, is the angle between target direction and the line between the two collimators. You call that value to the guy at the second collimator. He looks at your collimator with that value adjusted on his collimator.

As that value is the angle between the target and the connection line of the two collimators, **now the zero mark on his ring is on the target line!**

That way the target direction may be handed over from collimator to collimator until it reaches the A4, so the A4 (tailfin 1) may be rotated into target direction.

This whole procedure is needed because the rocket generally is located in a wooded area, for camouflage purposes, while the final bearing is referenced to a distant landscape mark that must be visible.

To maintain sufficient accuracy, the number of collimators is reduced to the minimum required, generally 2.

#### Parallax

The final bearing is calculated for the central point A. No corrections are made for the fact that the actual launch positions are not on position A. If all other errors were zero, the missiles would impact in exactly the same pattern as the launch positions, around target "A". In view of the overall system accuracy, this error was considered negligible.

---

For modern ideas the whole targeting procedure of the A4 is amazingly complex and time consuming. But the time obviously was available, because the rocket had a second big disadvantage: the fact that it had to be fuelled on its launch position. A unique concept for a weapon system, although not unusual in the space business.

The last part of the "A4 accuracy story" will be the control of the A4 itself, the way in which gyro and Leitstrahl signals were used to control the rudders and... (not to be forgotten) that most remarkable piece of engineering: the "Umlenk"-program.

That brings me to a question: were the A4 air rudders reset in neutral position just before (or after) Brennschluss? If not, how did it influence the re-entry flight path?? I never found a document about that!

---

I've never seen one of the special documents mentioned in this story. If someone has scans, please, send me a copy!

Launch site

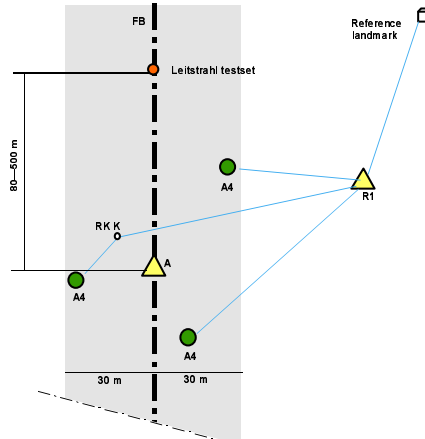

Brennschluss site

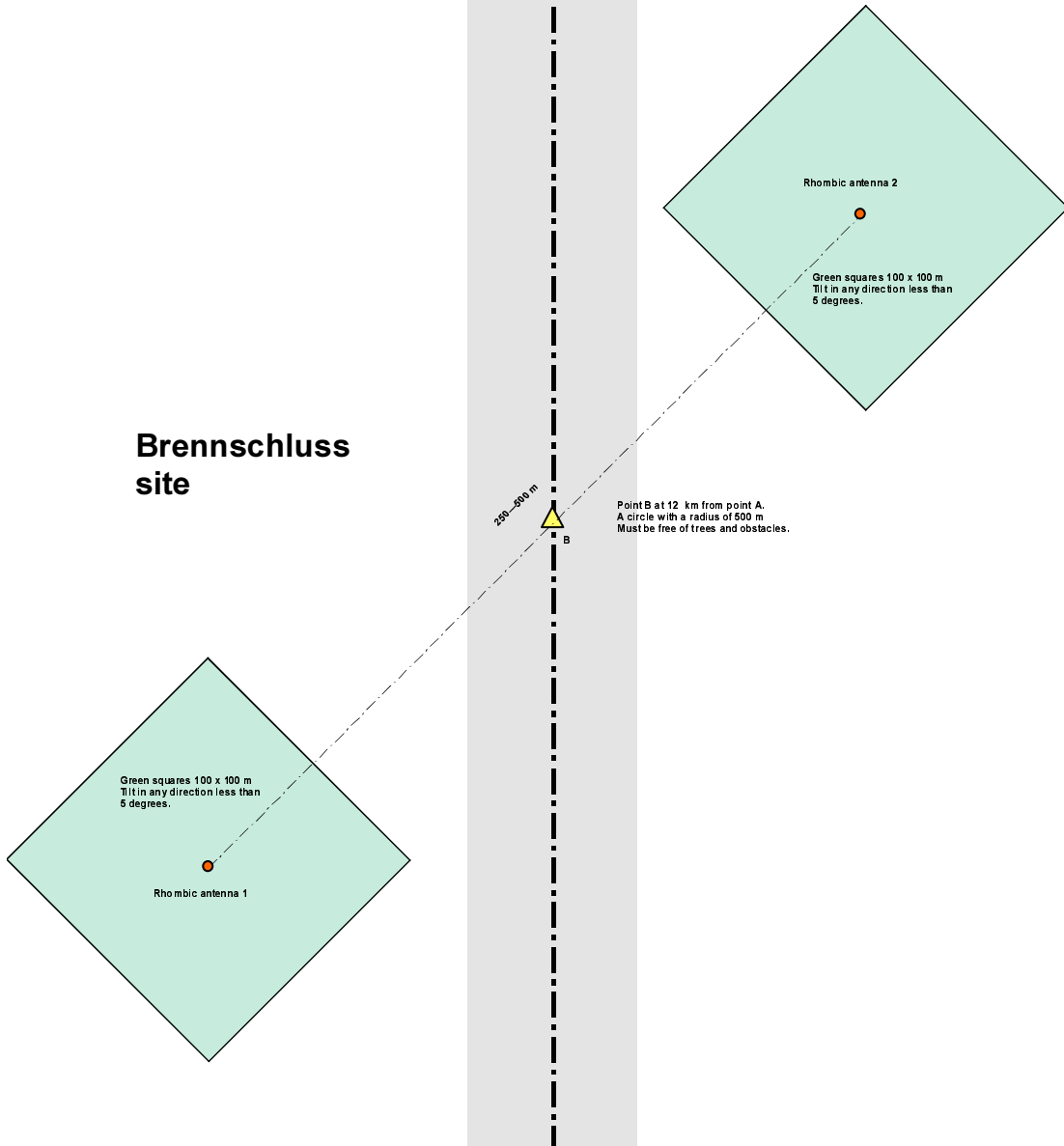

Launch site

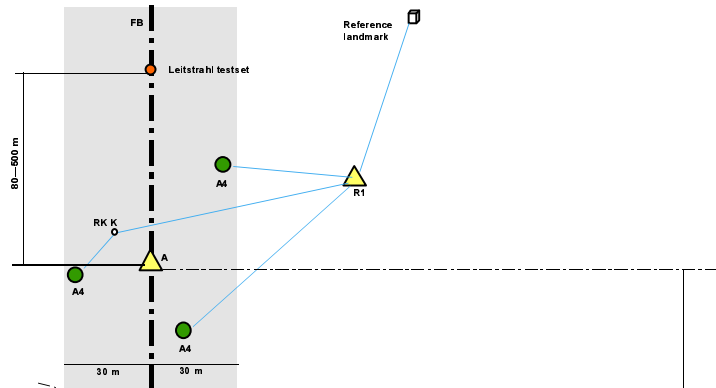

Leitstrahl site

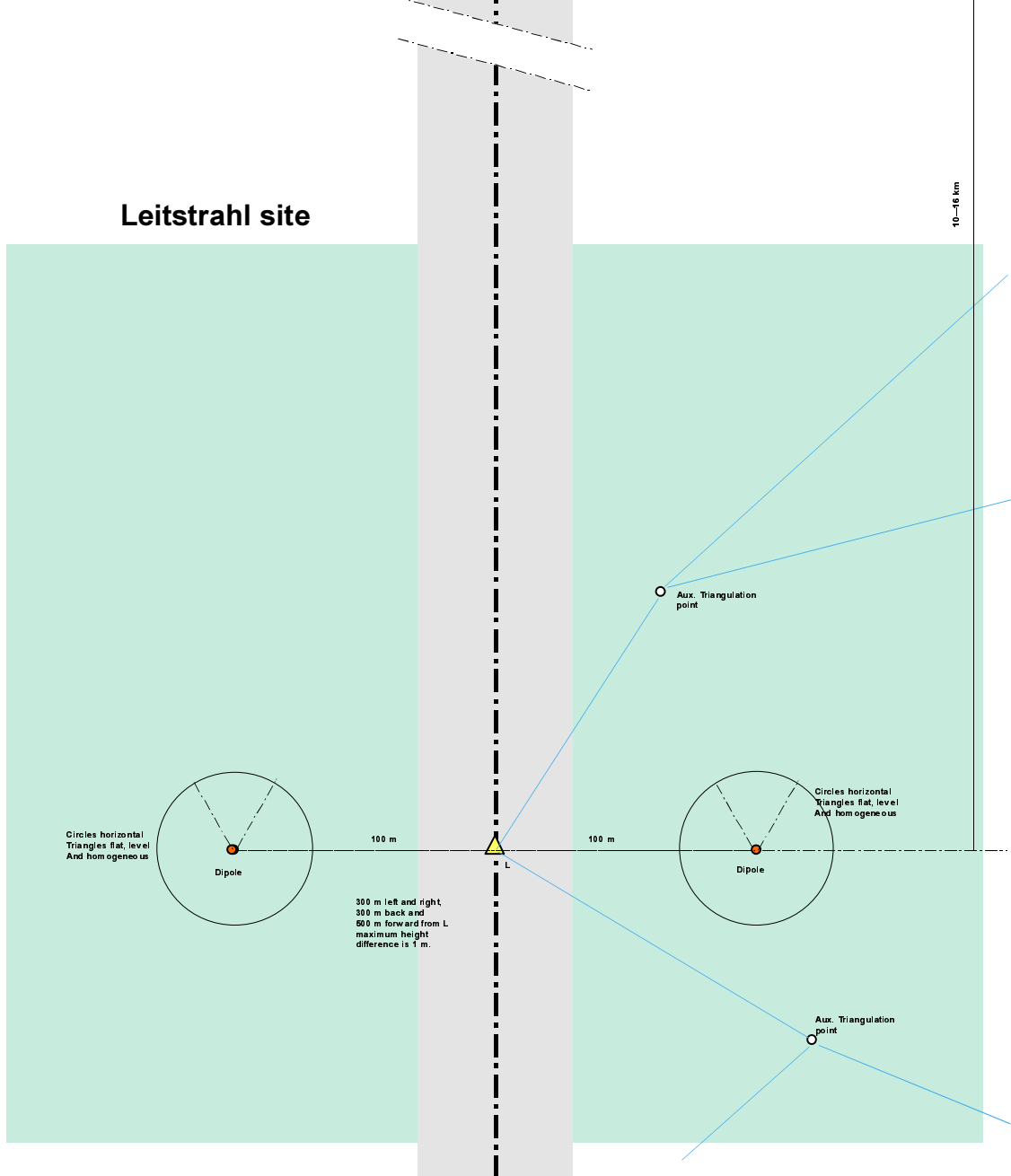

## The influence of earth rotation in the horizontal plane

The radius of this planet is 6378 km, so the circumference is  $2 \times \pi \times 6378 = 40074$  Km. A point on the equator turns around the earth axis in 24 hours, so the speed of a point on the equator is  $40074 : 24 = 1669.7$  km/h, to the east.

If one travels north (or south), the distance to the earth axis decreases, and so does the circumference of the circle, the distance to be travelled to make a full  $360^\circ$  loop in 24 hours around the earth axis. If one arrives at the north pole, the distance travelled as result of the earth rotation is 0 km, so the speed is 0 km/h.

The speed for every latitude is easily computed:  $1669.7 \times \cos(\text{Latitude})$ . The island Greifswalder Oie has a latitude of  $54.2^\circ$  North and consequently travels to the east with a speed of  $1669.7 \times \cos(54.2^\circ) = 976.7$  km/h.

A V2 launched from the Oie, does not only have a vertical velocity, ***it also has a horizontal speed of 976.7 km/h to the east!!!***

There is no friction to decrease this horizontal velocity, the earth atmosphere rotates east together with the planet, and outside the atmosphere there is no friction either. If the target moved east with a velocity of 976,7 km/h, the missile might be aimed directly to the target. If the time of flight were 6 minutes, the rocket would travel east over a distance of 97.67 km as a result of earth rotation, but the target would travel the same distance! Direct hit!!!

But only targets having the same geographic latitude do have the same velocity as the launch position. Targets to the north have a lower velocity (being closer to the earth axis) and targets to the south have a higher velocity than the launch position.

Therefore the missile has to be aimed east of the target for targets with a lower latitude (South) than the launch position, and west of the target for northern targets. (That was the The Hague-London correction of 1.15 km!)

This whole story sounds nice, but it is only partly true. It would be completely true for a low flying rocket, but the high V2-trajectory causes some additional trouble.

## The vertical aspect

To keep it simple, I did not cover this aspect in the original story, but some members of the IV2RG convinced me that I should. One of the remarks of Henk Koopman was: "Steilschüsse" (vertical launches) from Greifswalder Oie (where the "target" was identical with the launch position) landed way off "due to earth rotation", how can??

Corrections for earth rotation were, in the V2 deployment, very crude. All corrections were, as a single value, taken from one table, based upon an average latitude of target and launch position.

Apart from technical and climatologic reasons, there were two theoretical reasons, preventing the "Steilschüsse" from wrecking the launch position.

### 1. Altitude lag

First of all, let's give a precise definition of "over". A missile is "over" its launch position if its position is exactly on a line, drawn from the earth centre through the launch position.

A point on that line, 100 km “over” the launch position, also rotates around the earth axis in 24 hours. But the velocity of that point is not 976.7 km/h. The radius of its orbit is:

$$6378 \times \cos(54.2^\circ) + 100 = 3831 \text{ km.}$$

Consequently the velocity of that point is  $2 \times \pi \times 3831 : 24 = 1002.9 \text{ km/h.}$

The horizontal velocity of the rocket, however, is only 976.7 km/h! At an altitude of 100 km the rocket would need  $1002.9 - 976.7 = 26.2 \text{ km/h}$  more horizontal speed to keep up with our virtual point! So the rocket develops a lag with respect to the vertical line through the launch position. From the moment of launch, the altitude of the rocket increases, so the “lag-speed” increases. After reaching the highest point, the altitude decreases, so the “lag-speed” decreases, but all the time the “lag-distance” still increases. As a result of this “altitude lag” the rocket will impact at a point west of the launch position.

## 2. Coriolisforce

If a body follows a circular orbit, a centrifugal force will work on that body, forcing it away from the centre of the rotation. That force works along a line through the centre of rotation and the body. As the V2, as we have seen, rotates around the earth axis, it is subjected to a centrifugal force.

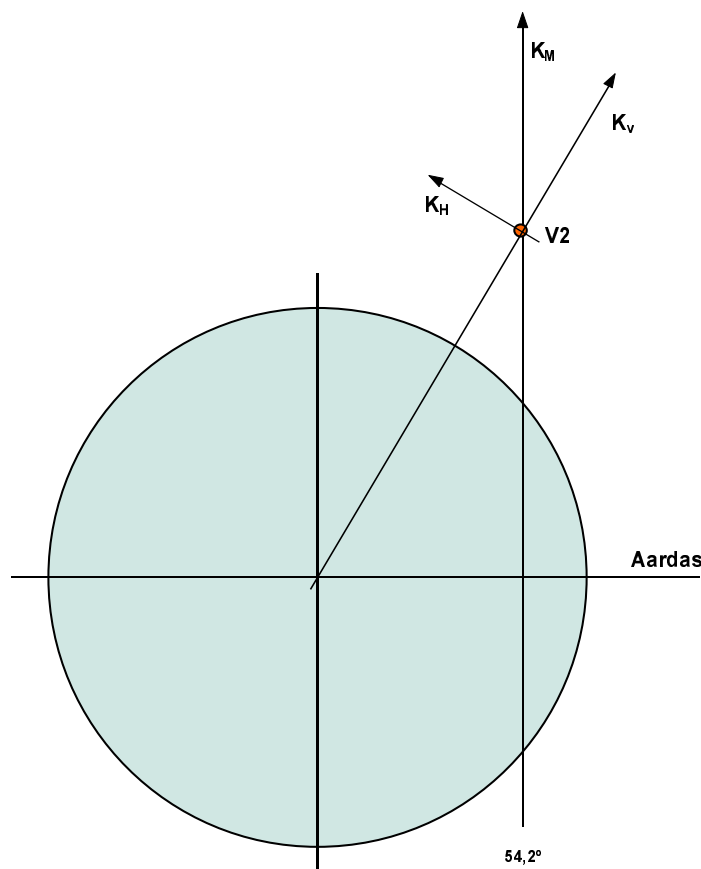

That force,  $K_M$ , may be split into two forces, a vertical force  $K_V$ , counteracting the gravitation, and a horizontal force  $K_H$ , pulling the missile in the direction of the equator.

The force pulling things up and in the direction of the equator is called “Coriolis-force” and plays an important roll in ballistics and meteorology.

It causes a higher (and consequently longer) missile trajectory and a deviation to the south. (On the northern hemisphere that is, on the southern hemisphere the deviation is to the north!)

Considering all this, you must realize that the V2 did not have a position control, it merely possessed an attitude stabilization system. The gyro's only could see a change in attitude, movements to the side, as a result from earth rotation,

wind, etc. remained undetected. The stable platform, still under development at the end of the war, had a set of accelerometers to detect side-movements and much better results could have been achieved after its completion.

All calculations in this story were made for a single point, to illustrate the principle. To get a realistic approximation of reality, those calculations have to be made for every point of the



trajectory and integrated. Furthermore I took some freedom in switching creatively between a flat and a spherical Mother Earth, to keep the story transparent. Anyway, the Germans used a more crude approximation of earth rotation influences than I did, so I feel excused.

# A4/V2 Brennschluss

## 1. Introduction

Literally translated the German word "Brennschluss" means "burning stop", and it was widely used to indicate the cut off of the A4/V2 rocket motor. The A4 was launched vertically and was tilted into the direction of the target by an internal control mechanism. The angle of tilt was constant, so the required missile range had to be obtained by cutting off the rocket engine at exactly the right missile velocity.

The Germans gave a high priority to development of Brennschluss-devices and, as they usually did in such cases, placed their bets on different horses.

- A system based upon wireless ground based speed measurement was designed by prof. Fassbender, Institut für Schwingungs-Forschung at Berlin. This system was the first one to be operational. It was complex and vulnerable to electronic counter measures (ECM), so development of on board solutions was emphasized.
- Kreisel Geräte, Berlin, developed a fully mechanical solution, the gyroscopic integrating accelerometer.
- Prof. Buchhold, Technische Hochschule Darmstadt, worked on an electrolytic integrating accelerometer.
- Prof. Huter, Technische Hochschule Darmstadt, worked on an integrating accelerometer too and
- The Firma Ott, Kempten, Bavaria, developed an unknown type of control.

The Brennschluss Bodenanlage (ground based control) was the first system in operational use. In a late stage it was replaced by I-Gerät 1/3, the gyroscopic integrating accelerometer. Production of I-Gerät 2, the electrolytic integrating accelerometer, was seriously delayed because it needed electron tubes and those were in short supply. The accuracy of I-Gerät 2 is claimed to be five times better than the accuracy of I-Gerät 1/3. Not much is known about its operational deployment.

## 2. The ground controlled Brennschluss solution.

### **About Frequencies and Wavelengths**

*Don't read this if you have a technical background!*

A transmitter-antenna transmits radio waves. In the antenna flows an alternating current that goes through a complete cycle  $n$  times per second. The frequency of that current is said to be  $n$  Herz.

The resulting electromagnetic radio wave travels at the speed of light, 300,000,000 m/sec. (In fact it is about 299792458 m/sec but who cares, that precise figure was not known during the war anyway).

If the transmitter-antenna radiates  $n$  waves per second and those waves propagate at lightspeed, a one-second train of waves has a length of 300,000,000 meters, so one wave

has a length of  $\frac{300,000,000}{n}$  meters. This is called the wavelength of the radio signal.

In physics the wavelength is generally noted as  $\lambda$  (Lambda), the speed of light is noted as  $C$  and the frequency is noted as  $f$ .

$$\text{So: } \lambda = \frac{C}{f} \text{ or } f = \frac{C}{\lambda} \text{ or } C = \lambda \cdot f$$

## About the Doppler-effect

Imagine a machinegun, firing  $n$  tennis-balls per second with a speed of  $C$  m/sec.

The frequency  $f = n$  balls/sec. The distance between two balls is  $\lambda = \frac{C}{f}$ .

A stationary target is hit with a frequency  $f$  (=  $n$  balls/sec).

What happens if the target moves away from the gun? The number of hits per second decreases. If the target moves away with  $C$ , the same speed as the balls, the number of hits even goes down to zero, so the receiving frequency is 0 Hz while the transmitting frequency is still  $f$  Hz or  $n$  balls/sec.

The *distance* between two balls is constant, but the *speed* of the balls, *relative to the target*, decreases if the target moves away from the source.

If the target moves away with a speed  $V$ , the speed of the balls versus the target is  $C - V$ .

If the distance between balls is  $\lambda$  and the speed of balls versus target is  $C - V$ , then

obviously the number of hits per second is  $\frac{C - V}{\lambda}$ .

Applied to a transmitter on the ground and a receiver in a vehicle moving away:

The transmitter transmits a frequency  $f_T$ , so the wavelength is  $\lambda = \frac{C}{f_T}$ .

The receiver receives a frequency  $f_R = \frac{C - V}{\lambda} = \frac{C - V}{\frac{C}{f_T}} = f_T \cdot \frac{C - V}{C} =$

$$f_T \cdot \left( \frac{C - V}{C} \right) = f_T \cdot \left( \frac{C}{C} - \frac{V}{C} \right) = f_T \cdot \left( 1 - \frac{V}{C} \right)$$

So a receiver moving radially away from a transmitter receives a frequency that equals the

transmitter-frequency multiplied with a factor  $\left( 1 - \frac{V}{C} \right)$ . The same applies, for obvious

reasons, if a transmitter is moving radially away from a receiver! If the movement is not exactly outbound,  $V$  is the *radial component* of the speed vector.

*Don't read this if you don't have a technical background!*

This formula applies to sound and other cases of transmission through a medium. As the theory of relativity proves that the speed of light is constant in every reference system, adding  $C$  and  $V$  is not possible. For light and (other) electromagnetic transmissions the Doppler frequency shift is based on the special relativity theory and the formula is:

$$f_R = f_T \cdot \left( \frac{\sqrt{1 - \frac{V^2}{C^2}}}{1 - \frac{V}{C}} \right)$$

It would take some 150 pages to derive this formula from scratch, so the "wrong" one will be used below. The good news: for the low speeds of an A4, radial measurement and a stationary reference system, the outcome of both formula's is almost identical. Anyway, I'm not so sure the Germans were aware of relativity-Doppler in the early 40's! If you have any information about that, please let me know!!

The frequency shift as a result of speed is called Doppler effect after the German scientist Doppler, who described this phenomenon for the first time. After Worldwar 2, speed measurement based on Doppler effect found a broad application in military equipment and, as you may have experienced, in traffic radar.

---

## Brennschluss Anlage A4/V2

As the A4 was a ballistic missile with a fixed “barrel-elevation”, the range of the shot had to be controlled by the “muzzle-speed”. This was achieved by cutting the engine at a predetermined missile velocity.

The engine cut-off system of the A4 consisted of a Doppler radio loop to measure missile velocity and a groundbased control transmitter to send the engine cut-off signal to the rocket.

Frequencies will be indicated as follows:

- $f_{TB}$  = Transmitted by Brennschluss Bodenanlage
- $f_{RB}$  = Received by Brennschluss Bodenanlage
- $f_{RR}$  = Received by rocket
- $f_{TR}$  = Transmitted by rocket

The Brennschluss Bodenanlage (BBA) transmitted a radio signal with a frequency of approximately  $f_{TB} = 30$  MHz.

The rocket, flying outbound with a velocity  $V$ , received this signal. Due to Doppler shift, the

frequency received was:  $f_{RR} = f_{TB} \left( 1 - \frac{V}{C} \right)$ .

This frequency was fed into an electronic device called “Verdoppler”. The word means “Doubler” and has nothing to do with “Doppler”-effect.

The Verdoppler was a simple frequency-doubler. The BBA-signal was received by an antenna and fed into an amplifier. After amplification it was rectified in a double phase rectifier circuit. That way the negative half of the sinewave is “folded” upward and so the distance between two positive tops is cut in half. Dividing the wavelength by 2 means doubling the frequency. But instead of a nice sinusoidal signal we now have a train of positive half sinuses. According to Fourier that means that the signal contains a lot of harmonic frequencies. In addition to the basic frequency  $f$  we find  $2f$ ,  $3f$ ,  $4f$ ,  $5f$  .....etc. in the rectifier output signal. A 60 MHz bandpass filter gets rid of all the unwanted stuff and outputs a clean sinewave, now with two times the frequency of the input signal. After amplification the signal is fed into a second antenna and transmitted.

The actual Verdoppler is complexer than this description suggests, but all additional circuitry serves anti-jamming purposes and has no influence on the principle of operation as described here.

So the rocket doubles the frequency of the signal received and retransmits it.

Transmission frequency of rocket:  $f_{TR} = 2 \cdot f_{RR} = 2 \cdot \left( f_{TB} \left( 1 - \frac{V}{C} \right) \right)$

The signal transmitted by the rocket is received by the BBA, but as the transmitter moves away from the receiver this time, we have to apply the Doppler-factor once more.

$$f_{RB} = f_{TR} \left(1 - \frac{V}{C}\right) = 2 \cdot \left( f_{TB} \cdot \left(1 - \frac{V}{C}\right) \right) \left(1 - \frac{V}{C}\right) = 2 \cdot f_{TB} \left(1 - \frac{V}{C}\right)^2$$

Now we must compare the BBA transmitting- and receiving-frequencies to find the (multiple) Doppler shift. The received frequency is two times the transmitted frequency minus a Doppler shift. To isolate the Doppler shift the receiver signal was mixed with the double transmitter frequency. A sample of the transmitter signal was branched to a frequency doubler like the one in the rocket and the result was mixed with the receiver signal.

A non-linear device like a mixer outputs the original frequencies, the sum and the difference of the inputted frequencies plus some harmonic rubbish. As the difference of both frequencies lies below 1000 Hz, extremely low compared to the input frequencies (~60 MHz) and the sum (~120 MHz), the Doppler frequency may be easily filtered out using a lowpass filter. So the total Dopplershift results in a frequency  $f_D$ :

$$f_D = 2 \cdot f_{TB} \cdot \left(1 - \frac{V}{C}\right)^2 - 2 \cdot f_{TB} = 2 \cdot f_{TB} \cdot \left\{ \left(1 - \frac{V}{C}\right)^2 - 1 \right\}$$

The relation between rocket velocity and Doppler frequency now may be calculated. A simple computer program may do the job. As the speed of light (C) is constant, the Doppler frequency is only dependent from two variables: the BBA transmitter frequency and the missile velocity.

The Doppler frequency, obtained by mixing the doubled transmitter signal and the receiver signal, is fed into a frequency measuring bridge of the Robinson type. This bridge is tuned to the required Doppler frequency. As the rocket accelerates, the Doppler frequency increases and the bridge goes through zero output and inverts the phase of its output signal. This is detected by a phase sensitive discriminator (of the ring modulator type) and the Brennschluss command transmitter is triggered to send its engine cutoff command.

The Brennschluss system did not have a possibility to correct for angular deviations, so it had to be positioned at a place where angular deviations are zero at the moment of Brennschluss. So the BBA had to be located at the spot where the tangent to the rocket trajectory, in the Brennschluss point, intersects with the earth surface. This rather impractical decentralization allowed for simple electronics without any computing capabilities at all. And it keeps the formula's as simple as shown above.

Later configurations generated two cutoff commands, the first one reduced rocket thrust from 25 tons to 8 tons and the second one turned off the engine completely. In that case the circuitry was almost identical, the first cutoff changed the crossover frequency of the Robinson bridge by switching capacitors and then the system waited for the second Doppler frequency to generate the second cutoff.

The fact that the receiving frequency of the BBA is almost twice the transmitting frequency, is illustrated by the sizes of both rhombic antennas: the transmitting antenna has about twice the size of the receiving antenna. (Antenna dimensions are a function of the wavelength!)

This system gives a good accuracy, but requires an elaborate organization, an offset position, extensive logistics and manpower and is vulnerable to enemy countermeasures like jamming.

So there was a strong preference for just one little box on board the missile to do the job.

### 3. The integrating accelerometers

#### About speed, acceleration, mass and weight

A resting object has a constant speed. As long as nothing happens it follows a straight line. Its speed is expressed in **m/sec**.

An object has two confusing properties: **mass** and **weight**.

To change the kinetic situation of an object a force must be applied to that object.

A force has always the same effect: it increases the velocity of the object in the direction of the force.

Velocity is expressed in **m/sec**, so increase in velocity is expressed in **m/sec/sec** or **m/sec<sup>2</sup>**. Increase in velocity is also called acceleration, symbol **a**.

Objects have inertia or mass, they resist acceleration. To give an object with a mass of **1 Kg** an acceleration of **1 m/sec<sup>2</sup>**, a force of **1 Newton** has to be applied.

So:

**$F = m \times a$**  or  **$m = F/a$**  or  **$a = F/m$**  (a = acceleration, F = force, m = mass)

Don't confuse mass and weight. Weight is the force applied to the object by the earth gravitation. For an object with a mass of 1 Kg that force is approx. 9.81 Newton.

The weight of your ribeye steak on earth is 6 times the weight of the same steak on the moon and the weight in free space is zero. But the mass is the same under all those conditions!!

Obviously every object in the earth gravitation field is accelerated downward with an acceleration of  $a = F/m = 9.81/1 = 9.81 \text{ m/sec}^2$ . This gravity-acceleration is generally noted as **g**. (And for ease of calculation it is rounded to  $10 \text{ m/sec}^2$ .)

So why do you sit in your chair without accelerating downward? For that question there are two (mathematically identical) answers:

- The (reaction) force applied by the chair plus the force of gravity add up to exactly zero. No force means no acceleration.
- You are accelerated downward with  $g \text{ m/sec}^2$ . The reaction force of the chair accelerates you upward with  $g \text{ m/sec}^2$ . So the resulting acceleration is zero.

In both cases: as soon as the reaction force ceases to exist, a downward acceleration  $g$  will start.

#### Intermezzo

Why discuss all this? We wanted to measure the velocity of an A4, so why don't we do just that?

Good idea! But how? In a closed system speed can not be measured. On a train, blindfolded and wearing a headphone, you can not tell whether you're moving forward, backward, fast, slow or you're not moving at all. And all speed indicators in planes and vehicles only give an indication of the difference in velocity between the vehicle and its direct surroundings.

*Acceleration* always is the result of a force, and a force may be measured. So we have to find a method to *calculate* the velocity from the acceleration we *measure*!

Suppose an object has a velocity  $V = 0$ .

The object is accelerated with  $a = 3 \text{ m/sec}^2$ . (Every second the velocity increases with 3 m/sec)

After 10 sec the velocity is  $3 \times 10 = 30 \text{ m/sec}$ .  **$V = a \cdot t$**

That's a nice way to calculate the speed from the acceleration and the time, but it supposes a constant acceleration! But what if the acceleration is not constant??

In that case we split the duration of the acceleration in very small time-slices  $\Delta t$ . We assume that the acceleration  $a$  during that short time is constant and we calculate the increase in velocity,  $\Delta V$ .

$$\Delta V = a \cdot \Delta t$$

We perform this calculation on all those little time-slices and add the results to obtain the final velocity.

$$V = \sum_0^t a \cdot \Delta t$$

The accuracy of the result increases if the time-slices are getting smaller and smaller. If they are infinitely small, the equation is:

$$V = \int_0^t a \cdot dt$$

This mathematical operation is called **Integration**. The final speed is calculated by integration (adding) of all momentarily measured values of the acceleration, multiplied by an infinitely small duration  $dt$ .

So the instrument needed for internal measurement of velocity in an A4 should measure the acceleration at every moment and integrate the results over time. That's why it is called **Integrating Accelerometer**.

### Intermezzo

Illustration of the need. How does an A4 accelerate?

After lift off the A4 rocket engine has a constant fuel consumption ( $c$  Kg/sec) and delivers a constant thrust ( $F$  Newton). The mass at launch is  $m_0$  Kg.

After  $t$  sec of flight the mass  $m_t = m_0 - c \cdot t$ . The acceleration after  $t$  sec of flight is :

$$a = \frac{F}{m_t} - g = \frac{F}{m_0 - c \cdot t} - g$$

Note that  $g$ , the acceleration of gravity, is subtracted from the thrust-invoked acceleration because the reaction of the launching table (chair!) fell away at the moment of lift off! Graphically it looks like this:

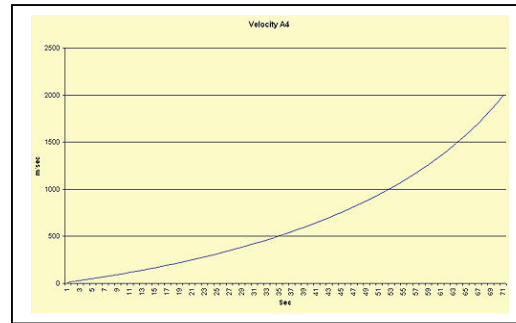
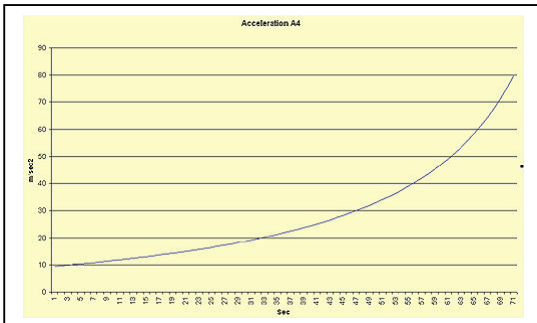

The graphs show acceleration and velocity of the A4 during the first minute of flight, using the equation above and representative figures for mass, fuel consumption etc. These graphs don't give a realistic representation of an A4 launch. In this example the rocket is not tilted towards the target, no velocity dependent air friction is taken into account, no

centrifugal forces. The sole purpose of these graphs is to illustrate that acceleration is not constant over the time, so that an integrating accelerometer is needed to calculate the missile velocity!

Now that we have some background information, let's have a look at some physical solutions!

## I-Gerät 1/3

The mechanical solution.

Sorry, but here is another mysterious thing: a gyroscope. Don't worry, no theory of impulse-moments, just a few facts. A gyroscope is just a fast spinning wheel. It tries to maintain the angular position of its axis. If one applies forces to tilt the axis in the North-South plane, it tilts in the East-West plane. That property of a gyroscope is called "precession".

A simple but very instructive test to illustrate precession and the principle of I-Gerät 1/3:

- Take the front wheel and axle from your bike. Hold both ends of the axle in both hands, with the wheel vertical. Let somebody spin the wheel and try to turn the axle over 90 degrees so the wheel lies in the horizontal plane. Surprise!
- Throw a rope over a high point and attach one side to one side of the axle. Hold both ends of the axle in both hands, with the wheel vertical. Let somebody spin the wheel. Let go of the axle. The axle starts rotating in the horizontal plane. Now pull the other end of the rope to accelerate the wheel upward. Observe that the horizontal rotation RPM increases.
- Put your bike together again and be proud of it! It's a gyro stabilized vehicle! That's why you balance so easy when the wheels rotate and so difficult at zero speed.

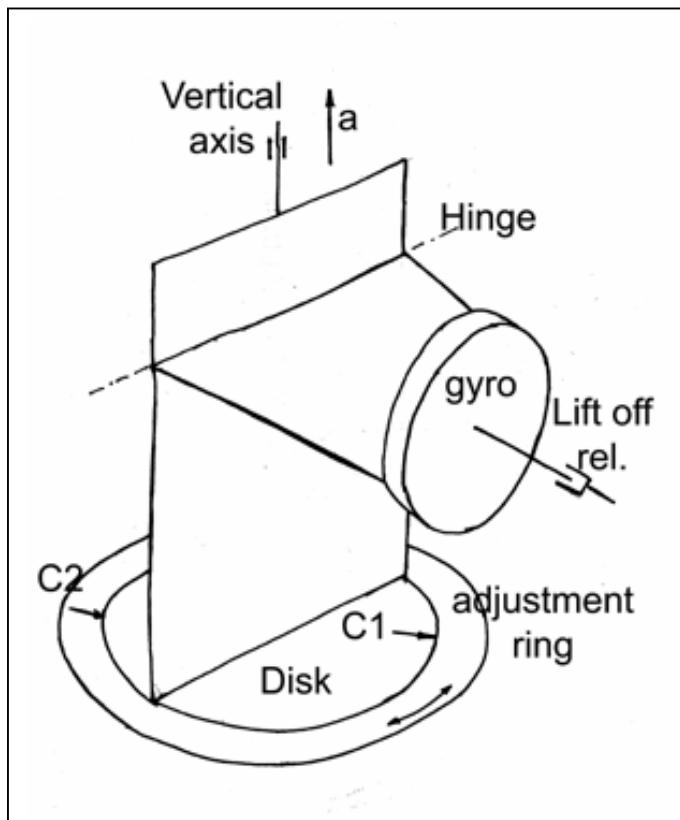

A gyroscope is mounted on a support and that support is attached to a vertical structure by means of a hinge. The vertical structure is free to rotate around its vertical axis. The gyro is mechanically released at the moment of lift off. The upward acceleration of the A4 plus gravity cause a force that tries to tilt the gyro downward. The precession of the gyro then turns the disk clockwise. The rotation angle of the disk per unit of time is proportional with  $a + g$  during that time. So the total angle of rotation of the disk is proportional with

$$V = \int_0^t a + g \cdot dt .$$

The adjustment ring is adjusted in such a way that the contacts C1 and C2 touch at the moment that the required velocity is reached.





The copper slab was attached to an arm (red in the drawing). That arm was in fact the pointer of a moving coil instrument, like a standard moving coil current meter.

At lift off the arm is released and a + g forces pull the arm down. The copper slab moves into the air gap of choke C2 and the bridge is unbalanced. The secondary of T2 gives output and that output is amplified by electron tube Ro2. The AC output of Ro2 is rectified by G12 and the resulting DC is fed through the moving coil. This causes the arm to rotate clockwise and lift the copper slab. The bridge unbalance decreases and so does the output of T2. Ro2 gets less input and gives less output, so the DC from G12 decreases. That makes the copper slab go down again ..... etc. The circuit finds a balance and the current through the moving coil is proportional with the acceleration.

Integration takes place in a rather exotic way: the current through the moving coil is led through an electrolytic cell, consisting of two polished silver electrodes, submerged in hydrochloric acid. One electrode is covered with a calibrated layer of silver chloride. The current through the cell transports silver chloride from one electrode to the other. As the current is proportional with the acceleration, the total amount of silver chloride transported is proportional with the missile velocity.

At the moment all silver chloride is transported, the rocket has reached its Brennschluss velocity and the voltage over the cell changes sharp.

The current in Ro4 changes and relay R8 triggers engine cut off.

This integrator contains two cells, one for thrust reduction from 25 to 8 tons and one for full stop.

Switching contacts allow a reverse current flow through the cells in order to "charge" them with a calibrated layer of silver chloride. The thickness of the layer is controlled by the charging time and the charging current. During this "charge" the accelerometer is working stationary, so the acceleration is **g** only.

**$V = a \cdot t$**  so  **$t = V/a$** , or in this case:  **$t = V/g$** . To calibrate the I-Gerät for a Brennschluss velocity **V** the cells are charged with a stationary accelerometer, during  **$V/g$**  (=  $V/9.81$ ) sec.

This accelerometer owes its better accuracy to the internal feed back loop. Shortage of electron tubes delayed production and deployment considerably and little is known about operational use. Numbers of this type of control had been given into production at the end of the war.

Some publications state that the name I-Gerät comes from the Bavarian river Isar.

"Gerät" is German for "unit" or "piece of equipment".

I-Gerät is a logical abbreviation of "Integrations-Gerät". "Isar" was the word in some spelling alphabets for the letter i, and that might be the reason for the term "Isar-Gerät".

A NATO soldier would have called it an "India-box".

## **The V2 Leitstrahl (Guidance beam) system**

In an early stage of A4-development there were attempts to improve both the bearing- and range-accuracy of the rocket. The old Lorenz instrument landing system was adapted to improve the bearing accuracy. That system used two radio beams, one transmitting dots, the other one transmitting dashes. If the pilot heard dots on his headphone, he was too far left, when he heard dashes he was too far to the right. If he heard an uninterrupted tone, (dots plus dashes) he flew exactly in the intersection plane of the two beams, straight to the runway. Or to the target, for the Luftwaffe adopted the system to guide bombers to their English targets.

V2's had one little disadvantage: no pilot. So the system had to be adapted to enable automatic piloting of the rocket.

In this age of digital control and hi-definition radar it's interesting to see how they solved the problem in the 1940's.

On request of some group-members I have tried to keep it as simple as possible, so this time there are hardly any equations. Sorry, I could not do it without some technical lingo, it's hard to explain electronics (even WWII-electronics) without it.

### **About antenna-diagrams**

An antenna radiates electro-magnetic power. Some antenna's are built to radiate in all directions, some are built to radiate as much power in one direction as possible. If you walk around an antenna, describing a big circle, you may use a measuring instrument to measure the radiated power. If you note that field strength for every degree of angle, you may draw 360 arrows, one every degree, each one with a length representing the field strength measured in that particular direction. If you draw a line through all the arrow points, it looks like the black line in the figure below.

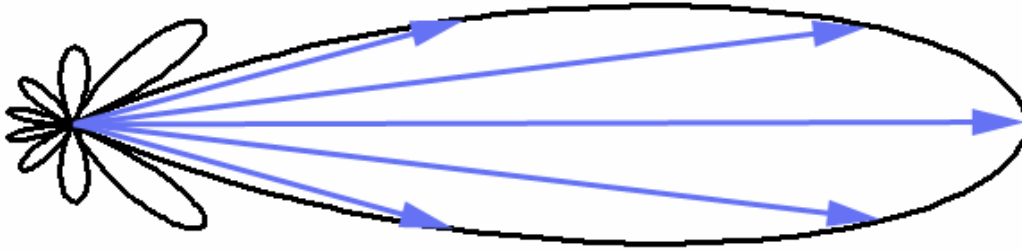

You'll see that there are a number of "sausages" around the central point, a big one and a number of small ones. The big one, the "main lobe", is the one we want, the small ones, the "side lobes", are unwanted, but an unavoidable consequence of the behaviour of radio waves. *(For the engineers: all these diagrams may be described with some variant of  $\sin(x)/x$ )*

The black line is called an "antenna diagram" or "antenna pattern" or "radiation pattern". The blue arrows point in a direction and their length is proportional with the power radiated in that direction. (Or the receiving sensitivity in that direction, if it is a receiving antenna.)

On both sides of the longest arrow there is a spot where the arrow, belonging to it, is exactly half as long as the longest central arrow. The angle, enclosed between those two arrows, is called the "beam width".

This diagram illustrates the radiation characteristics in the horizontal plane. A diagram measured in the vertical plane may look very different. For many applications the horizontal beam-width is very much smaller than the vertical beam-width.

### About the Leitstrahl ground station.

The Leitstrahl ground station has two of those directional antennas, one with its main lobe pointing a few degrees left of the target-line, the other one pointing the same angle right of the target line. So we get two identical, intersecting radiation patterns.

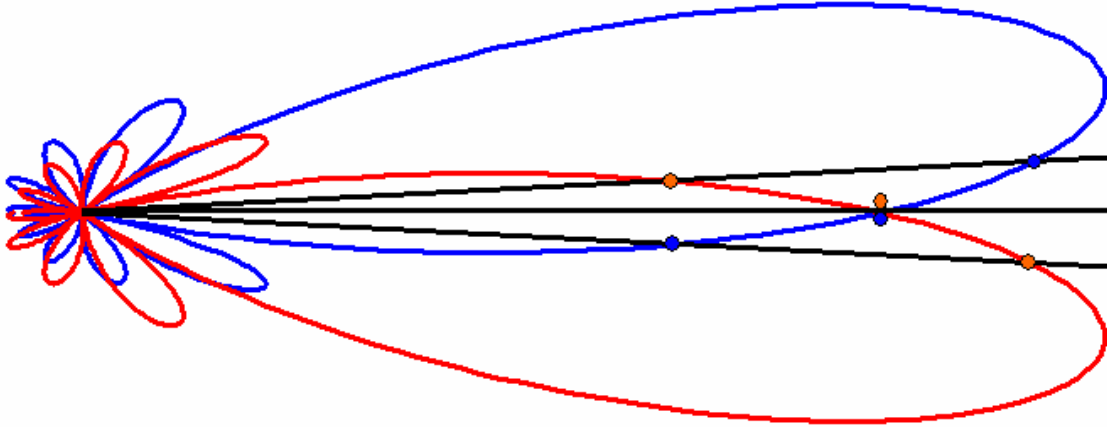

It will be clear from the diagram that, as long as a V2 is on the target line, it receives identical field strengths from the red and the blue lobes. So guidance is easy: just tell the rocket that it has to stay in the plane of equal field strengths to reach the target.

But...the rocket has no way to know whether the radio signal it receives comes from the blue or the red antenna. Both are fed by the same transmitter!

To solve that problem, the Germans decided to use one antenna at a time. They built a fast switch between the transmitter and the antennas in such a way that the transmitter alternately supplied each antenna with power. Each of the two antennas radiated 50 times per second, during 1/100 second.

Only if the V2 flew exactly on the target line, it received an uninterrupted, smooth signal, because the "red" and the "blue" signals had equal strength. As soon as it deviated to the left or to the right, one of the signals got stronger and the other one weaker, so the rocket received a 50 Hz "modulated" signal: strong-weak-strong-weak-strong weak etc.

In the diagram you may clearly see that on target-line the blue and the red signal are equal, that a little left from target-line the blue signal is much stronger than the red one and that a little right of the target-line the red signal is way stronger than the blue signal.

The rocket knows that it is off target-line, so it may correct to the "weak" side.

But..... the rocket has no way to know what side is the "weak" side, left or right, blue or red. So to enable the rocket to correct its course, it must be able to discriminate between the red and the blue lobe. The two signals had to be coloured. The Germans did that by modulating the left and the right beam with two different frequencies: 7 kHz and 5 kHz.

Finally the rocket had the opportunity to think:

- I see a 50 Hz modulation, so I'm off target-line.
- I see that the weaker part of the signal has a 5 kHz modulation.
- The right (red) lobe has a 5 kHz modulation, so I have to steer to the right.

If there is no 50 Hz modulation, the rocket is on target-line and no corrections are made.

---

I could have easily explained this system without mentioning side-lobes etc., but they are one of the reasons that there has to be a considerable distance between the rocket and the Leitstrahl ground station. Side lobes, ground reflections and near-field phenomena make that

a stable beam-shape, so a reasonable guidance plane, is only obtained at a considerable distance from the transmitting antennas. Furthermore an asymmetrical landscape, or aircraft flying within the beams, may distort the beams in such a way that the medicine is worse than the disease. Under optimal conditions, however, Leitstrahl might contribute to system accuracy.

The figure below illustrates the signal-configuration described in this paragraph.

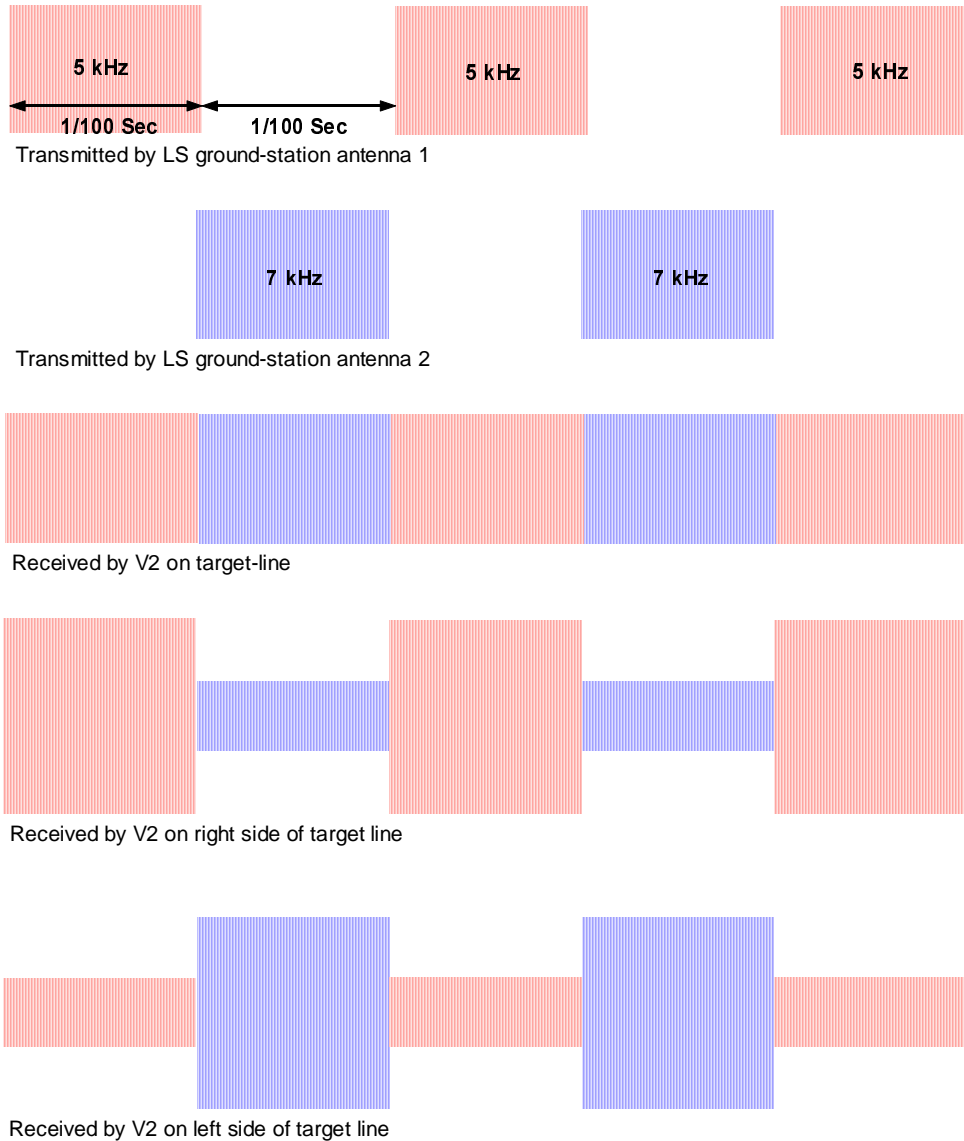

Now we will have a look at the way these signals are processed on board the rocket.

## About the Leitstrahl board equipment

The Leitstrahl receiver, known as "Victoria", was located in sector IV of the V2 equipment bay. It was connected to the tail-side rod-antennas. The (superheterodyne) receiver amplifies and demodulates the antenna-signal and feeds it into two different channels: the signal-

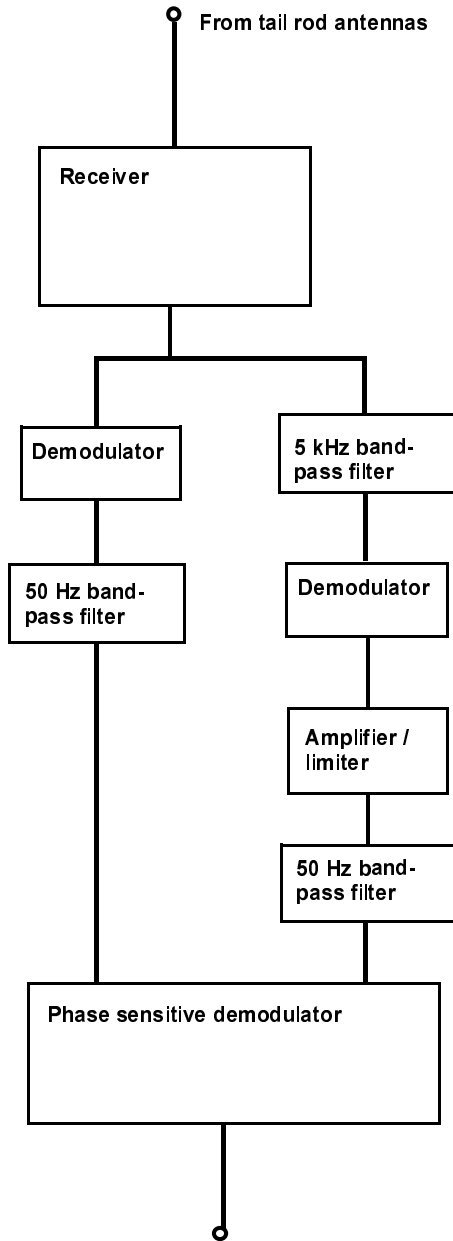

Output to rudder control computer (Mixer)

channel on the left side and the reference-channel on the right side. The receiver output is a train of 1/100 sec blocks of alternating 5 kHz or 7 kHz, with an amplitude dependent from the rocket position. If the rocket is on the target-line, the 5 and 7 kHz blocks have the same amplitude (height or voltage). If the rocket goes left of the centre-line, the 5 kHz blocks are growing, the 7 kHz blocks are shrinking, when it goes right, the opposite happens.

### The reference channel

The 5 kHz bandpass filter passes only the 5 kHz blocks and stops the 7 kHz blocks. So at the filter output there is 1/100 sec. 5 kHz, 1/100 sec nothing, and so on.

This signal is rectified in the demodulator, resulting in a block-shaped wave, positive when the "red" transmitter transmits, and negative during the "blue" period.

The amplitude of this block-wave is dependent from the rocket position, but we don't need that information, the only thing we want is a time- or phase-reference. So we "standardize" the block-wave in the amplifier / limiter, first the signal is amplified and then the tops are shaven off, so we get a standard, rocket position independent amplitude.

Then the signal is fed into a 50 Hz band-pass filter that rejects all harmonics and noise and delivers a sine-wave, standard amplitude, reference signal, positive when the "red" antenna radiates and negative when the "blue" antenna radiates.

### The signal channel

The receiver signal was rectified in the demodulator, so the demodulator output follows the envelope of the receiver signal. That output is fed into another 50 Hz band-pass filter.

If that envelope is a straight line (rocket on target-line) there is no 50 Hz, so the filter output is zero. If the rocket is off target-line, the filter output is a 50 Hz sine-wave, its amplitude dependent from the

distance between rocket and target-line, in phase (positive tops at the same time) with the reference signal if the rocket is left of the centre-line, out of phase (positive top of the signal at the same time as negative top of the reference) if the rocket is right of the centre-line.

### The phase sensitive demodulator

The outputs of the signal-channel and the reference channel are compared in the phase sensitive demodulator. Its output is zero if the rocket is on the target-line, positive if left, negative if right of the target-line. The output voltage is a function of the magnitude of the position error. This voltage is fed into the (analog) rudder control computer or "Mixer" or "Mischgerät", and is used, together with the attitude-error signals from the gyroscopes, to control the A4 rudders.

---

The V2 Leitstrahl system worked on a frequency of 60 MHz. The output power was 1 kW. The "red" and the "blue" antennas were dipoles. They were positioned on a line, perpendicular to the target-line, one 100 m to the left of the target-line, the other one 100 m to the right.

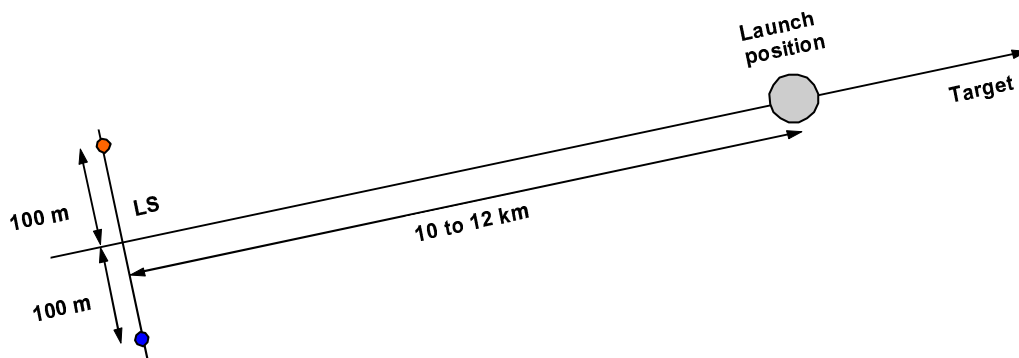

The system was very dependent from radio propagation conditions. Ground- or aircraft-reflections could have a fatal impact on system accuracy. The time available to obtain a stable rocket course was limited: after Brennschluss no jet rudders were available any more and tail rudders must have been pretty ineffective at that altitude. As far as we know the system was never tested in hills or mountainous country. Organizational and logistical problems alone were such that in most cases the Leitstrahl Verfahren was omitted.



## **A4-propellants and auxiliary substances**

### **A-Stoff**

Fluid oxygen

Bluish fluid, boiling at -183 degrees C.

Extreme risk of fire. Many accidents during deployment and testing may be due to lack of ESD-awareness.

Use: rocket propellant

### **B-Stoff**

40% Ethanol + 35% Methanol + 25% Water (+ sometimes Akorol as corrosion protection)

Artificially colored blue – violet to warn against consumption.

Alcohol smell.

Use: rocket propellant

### **T-Stoff**

79% Hydrogen peroxide + 21% Water

Transparent yellow to colorless syrupy fluid.

Faint Ozone smell, makes eyes water.

Instable, reacts violent with almost all organic substances.

Must be stored separately far away from other fuels, oils etc., must be transported by separate vehicle

Use: generation of fresh steam

### **Z-Stoff**

27% Sodium permanganate + 73% Water

In earlier stages:

27% Potassium permanganate + 73% Water

Sodium permanganate replaced Potassium permanganate because it easier solves in water.

In English documentation Kaliumpermanganat (Potassium permanganate) is frequently erroneously translated as “calcium permanganate”.

Deep dark violet fluid, no specific smell.

Use: generation of fresh steam (catalysis)

### **P-Stoff**

Compressed air or nitrogen

Use: pressurizing purposes

### **C-Stoff**

Hydrazine hydrate + Methanol + some water + additive

Yellowish fluid

Stinging fishy smell

Packed in special bottles together with T-Stoff.

Use: provides the ignition flame for the rocket engine.

A pyrotechnical, swastika-shaped, ignition-device may be used instead.

## Orders and activities concerning the A4 missile launch

<u>Order:</u>	<u>“Prepare missile to erect.”</u>	
Train leader	K1 and K3	left of the towbar ) Remove towbar and
	K2 and K4	right of the towbar ) set it aside.
	K6 and K7	open the buckles and zippers of the topside tarpaulin up to the belt.
	K8, K10, K11, K12	right ) Open and remove
	K9, K11, K13, K15	left ) tail tarpaulins
<u>Order:</u>	<u>“Outriggers out”.</u>	
Transport leader	K1, K3, K5	left ) Pull out and secure outriggers.
	K2, K4, K6	right )
	U2, K3, K4	Level the trailer
	U1	Inspection of the combustion chamber
	U3	Inspection of the rudders
<u>Order:</u>	<u>“Pull out and hook up the Stotz connectors.”</u>	
Electro leader	K12, K13	hook up the Stotz connectors and observe the cables during elevation.
<u>Order:</u>	<u>“Bring up the launching platform.”</u>	
Train leader	K6 at the hydraulic control	K7 at the engine
	K5, K8, K11, K14, K21 bring up the launching platform	
<u>Order:</u>	<u>“Loosen turntable securing, turn turntable.”</u>	
Transport leader	K8, K11	loosen the securing device and turn the turntable until the device points towards the missile trailer.
<u>Order:</u>	<u>“Lower the launching platform.”</u>	
Transport leader	K8, K10	lower the right hand level-jacks
	K9, K11	lower the left hand level-jacks
	K5	operates the winch
	K14, K21	remove and park the trailer
	K8, K11	pull out the securing pins of the blast deflector
<u>Order:</u>	<u>“Hook up the valve box.”</u>	
Propulsion leader	K3, K4	place and secure the valve box
<u>Order:</u>	<u>“Erect missile.”</u>	
Train leader	K7	start engine (report when full RPM)
	K6	operate hydraulic control, elevate frame
<u>Order:</u>	<u>“Easy – stop – cut engine.”</u>	
Transport leader	K6	operates hydraulic control
	K7	cuts engine
<u>Order:</u>	<u>“Jack up table.”</u>	
Transport leader	K8, K11	jack up the table
<u>Order:</u>	<u>“Lower missile.”</u>	
Transport leader	K6	lowers missile

<u>Order:</u>	<u>"Open belt."</u>		
Transport leader	K1	climbs on left footholds	) release belt
	K2	climbs on right footholds	)
	K2	remove belt securing pins	
		opens zipper completely	
<u>Order:</u>	<u>"Bolts out."</u>		
Transport leader	K5	operates bolts-spindle	
<u>Order:</u>	<u>"Open pincers."</u>		
Transport leader	K12	climbs to the pincers, opens them and then	
		opens the tarpaulin ribbon	
<u>Order:</u>	<u>"Start engine, lower elevation frame."</u>		
Transport leader	K6	hydraulic control	
	K7	engine	
	K10, K11	raise the missile trailer jacks	
<u>Order:</u>	<u>"Everybody to the missile trailer", "Trailer back."</u>		
Train leader	U2	checks the 90 cm distance	
	K7	operates the brake	
	K10, K11	check the outrigger jacks	
<u>Order:</u>	<u>"Lower level jacks."</u>		
Transport leader	K10, K11	lower the level jacks and set the elevation frame plumb	
<u>Order:</u>	<u>"Turn missile."</u>		
Train leader	K8, K9	use ratchets to turn	
<u>Order:</u>	<u>"Lower platforms."</u>		
Transport leader	K5	operates cable winch. If platforms do not fall:	
	K1, K2	lower platform	
	K14, K15	middle platform	
	K12, K13	highest platform	
<u>Order:</u>	<u>"Raise elevation frame."</u>		
Transport leader	K6		
	K7		
<u>Order:</u>	<u>"Cut engine."</u>		
Transport leader			
Train leader reports to battery officer: "Missile erected." On order of the battery officer the geodetic team sets the missile plumb.			
	K8, K11	operate the level-jacks	
<u>Order:</u>	<u>"Connect fivefold coupler and compressed air supply."</u>		
Propulsion leader	K3, K4	connect the fivefold coupler, desiccation cartridges and compressed air leads to the valve box.	
	K1, K2	on the middle platform, open the hatches to the steam generator, secure the manometer panel, connect it, disconnect the steam generator connector, place protection caps or connect test boxes.	

<u>Order:</u>	<u>"Place lift-off switch."</u>
Transport leader	K16, K17 place and secure the antennas under fin 2 and 4. K12, K13 get the actuators for the on-board and ground lift-off switches. On-board actuator to be placed under fin 1, ground based actuator to be placed under fin 2. Connect cables to the valve box receptacles.
<u>Order:</u>	<u>"Bring Magirus ladders."</u>
Transport leader	K18, K21 get and operate M. ladders. Simultaneously by cable troop: connect the cables to the missile trailer
<u>Order:</u>	<u>"Open hatches."</u>
Transport leader	K6, K8 open hatches 2 and 3 (when K12 and K13 are ready, they assist) K9 opens hatch 1 from the Magirus ladder
<u>Order:</u>	<u>"Prepare combustion chamber."</u>
Propulsion leader	K4, K5 place paper bags
<u>Order:</u>	<u>"Test board net."</u>
Electro leader	K12, K13 test insulation resistance of the board net (bring Ohmmeter)
<u>Order:</u>	<u>"Connect Stotz connectors."</u>
Electro leader	U3 warn power supply truck to connect the backup battery K12, K13 Stotz connector 1 left ) connect with a sharp, Stotz connector 2 right ) powerful push. (1 first!) K12 report: "Stotz connectors connected."
<u>Order:</u>	<u>"Switch on board supply x (1 or 2 or 3)"</u>
Electro leader	U3 gives order to the propulsion panel and, after switching, reports "Board power supply ready" to the train leader.
<u>Test:</u>	<u>Radio command receiver and frequency doubler</u>
	K16, K17 (Radio engineer supervises). After test <u>report</u> to the train leader when test was commenced and when test was terminated.
<u>Test:</u>	<u>Test of controls</u>
control equipment engineer	K14, K15 (Control equipment engineer supervises) After test <u>report</u> to battery officer when test was commenced and when test was terminated.
<u>Order:</u>	<u>"Build in the board battery."</u>
Electro leader	K12 builds in the board battery behind hatch 1 K13 builds in the command source battery behind hatch 3
<u>Order:</u>	<u>"Attach the jet rudders."</u>
Electro leader	K14, K15 attach the jet rudders, place the security covers
<u>Test:</u>	<u>"O<sub>2</sub> tankpressurazation"</u>
Train leader	

Orders at the propulsion panel

	<b>Order:</b>	<b>Response:</b>
Train leader	"Board supply x on"	"Is on"
	"Test switch at position 6"	"Is on 6"
	"Push test button"	"Pushed, K-light on"
	"Vent- or launch-switch at position E"	"Is on E"

Vent closes and compressed air flows into O<sub>2</sub>-tank.

Observe pressure gauge in valve box. At approx. 1.5 at the pressure switch terminates pressurization. That means: tank pressure is controlled. If the NCO at the propulsion panel reports: "Tank pressure is controlled" then order: "All switches off."

Test: "Ignition valve and ignition control circuit"

Train leader orders to propulsion panel

	<b>Order:</b>	<b>Response:</b>
Train leader	"Board supply x on"	"Is on"
	"Test switch at position 2"	"Is on 2"
	"Push test button"	"Pushed, K-light on"
	"Launch-switch at position E"	"Is on E, light is on"
	"Launch switch at position Z"	"Is on Z"

(At the valve box now compressed air must vent. On a sign K3 disconnects the short-circuit connector at the valve box and shows it to the train leader. Only now respond: "Z-light is on")

"All switches off"

"Off"

K3 reconnects the short-circuit connector. Train leader reports to the battery officer: "Missile ready for general functional circuit test."

Order: "Prepare for general functional circuit test."

Battery officer

Order: "Push converters and board auto-fuses. Prepare to catch the Stotz connectors."

K12 pushes converters and auto-fuses in Kl. 2.  
response: "All pushed".

K12, K13 hold Stotz-connectors

Test: General functional circuit test

Orders to propulsion panel:

	<b>Order:</b>	<b>Response:</b>
	"Board supply x on"	"Is on"
	"Key in launch position"	"Is in launch position, K-light on"
	"Push test button"	"Pushed, K-light on"
	"Launch-switch at position E (Vent-light on, indicator box)"	"Is on E, light is on"
	"Launch switch at position Z"	"Is on Z"

On sign K3 disconnects short-circuit connector on valve box and shows it to the battery officer.  
Response: "Z-light is on"

	<b>Order:</b>	<b>Response:</b>
	"Launch switch on V (Pre-stage)"	"Is on V, light is on"

Control battery tff – tff  
Launch switch on H (main stage)  
(Testbox shows "High pressure" light. Rubid contact up. 8 and 25 t lights.)  
Raise hand. Electro leader drops lift off contact under fin 1.  
After 4 seconds rudders 2 and 4 deflect synchronous to fin 1. After 40 seconds the pressure valve closes audible.

Order: Brennschluss (on the test box the 25 to light and after 3 seconds the 8 to light extinguishes).

	<b>Order:</b>	<b>Response:</b>
	"All switches off"	"Are off"

Order: "Auto-fuses off"  
Electro leader K12 pushes auto-fuses off and reports "Is off".  
U3 reinstall the lift-off switch under fin 1.

Order: "Connect Stotz connectors"  
Electro leader K12, K13 connect Stotz connectors and report: "Are connected".

Order: "Test board battery"  
Electro leader K13 tests board batteries behind hatch 1.

Order: "Close hatch 1"  
Electro leader K9 closes hatch 1.

Order: "Fuel handling."  
K10, K11 connect the B-Stoff hose from the pump-trailer to the missile trailer.  
K6, K8 get the connection hose to the missile. Connect the B-Stoff hose to the high platform.

Train leader: report the number of liters, to be set, to the leader of the pump-trailer. Missile ready for fuelling.

Train leader: After fuelling 1000 liters, fill the cooling wall of the combustion chamber completely.

Order: "Board supply x on" Response: "Is on"  
to propulsion Testswitch on 5 (fuelling) Response: "Is on 5"  
panel Push testbutton Response: "Is pushed"  
(Train leader) After 10 – 15 seconds: All switches off  
Now repeat the same procedure.  
If no fuel leaks from B-Stoff leak pipe,  
then proceed with fuelling.  
K10, K11 disconnecting the B-Stoff hose from the missile trailer

K6, K8 disconnecting the B-Stoff hose from the missile closing hatch 3 if the command generator battery is OK.  
 Train leader: Reports to battery officer: "Fuelling complete" and the fuelling duration from .... to ....

Order: "Fill T-Stoff calibration container"

K10, K11 Dress in protective clothing and place water bucket on lower platform.  
 K10 connect T-Stoff fuelling hose to missile trailer.  
 K11 sets three way valve open. Closes spill-over and fuelling valves.  
 U1 Reports: "Ready to fuel T-Stoff".

Order: "Start fuelling."

K1 connects the T-Stoff inlet.  
 K11 Observes the pressure gauge at the T-Stoff calibration container. Signal to engine guard if spill-over tank is half full. Close three way valve. Open the spill-over valve and close it when the spill-over tank is empty. Disconnect and rinse the fuelling hose.  
 U1 Report: "T-Stoff calibration container fuelled."

Order: "Fuel missile with T-Stoff"

K1, K11 Connect the T-Stoff fuelling hose to the inlet.  
 K11 Open the fuelling valve until T-Stoff is passed, then close the valve. Disconnect the hose and rinse the calibration container and the hoses with water.  
Report: "Fuelled with T-Stoff."

Order: "Oxygen fuelling."

K1, K2 Connect the A-Stoff fuelling connection, the hose and the filters between the missile trailer and the missile. Open the one-way valve at the fuelling connection.  
 K4, K5 Connect the A-Stoff hose between the pump and the missile trailer. Place the O<sub>2</sub> air-vent in the blister between fin 1 and 2.  
 K3 Checks if the fuelling and the emergency control pressure line are open.  
 U1 Report: "Ready for O<sub>2</sub> fuelling."

After fuelling:

K1, K2 Close one-way valve. Remove the fuelling connection, the B-Stoff hose and the filters from the missile trailer.  
 K4, K5 Remove the A-Stoff hose.  
 Train leader: Reports to battery officer: "O<sub>2</sub> fuelled." (Report starting time, spill-over and fuel quantity.)

Order: "Prepare ignition."

K5 Install the ignition cross in the combustion chamber.  
 K3, K4 Install ignition bottle. connect pipeline from ignition cross and fork to the ignition bottle. Do not yet connect the line to the valve box. Connect the connector of the ignition control circuit.

Order: "Push board auto-fuse"

Electro leader K14, K14 push the board auto-fuses, report: "Is pushed" and close hatch 2.

Order: "Adjust reduction valve"

Train leader U1, K1 adjust reduction valve, remove the blind connector at the steam generator, connect the connector and secure it. Check if the pressure gauge indicates 200 ato. Close the hatch.  
K2 Remove the pressure gauge lead. Close the hatch.

Order: "Fuel Z-Stoff."

Train leader K1, K2 take over a Z-Stoff container. Remove the blind cap. Place Z-Stoff filter inlet and pour the contents of the container in it.  
Train leader: reports: "Z-Stoff fuelled"  
K1, K2 close hatch.

Order: "Everybody to the missile trailer."

Train leader K7 at the brake  
K10, K11 raise the level-jacks of the missile trailer, all other gunners pull the missile trailer 3 m back.

Order: "Turn and aim the missile."

Train leader K8, K11 turn manual with ratchets, collimator team aims.  
K1, K2 hook up and secure the net to catch the Stotz connectors.

Order: "Missile trailer back"

Train leader All gunners pull the missile trailer back 3 more meters.  
K8, K9 set up protection sheets in before the front wheels.

Order: "Leave the launch position."

Train leader Everyone leaves the position.  
U1 connects the compressed air lead to the ignition bottle and disappears.  
Train leader reports to battery officer: "Launch site cleared, missile ready for launch."

K = Kanonier = "Gunner"

U = Unteroffizier = NCO

Train leader, Transport leader etc. are functions, not ranks.

Typical A4-unique terms like Brennschluss or A-Stoff are not translated to maintain "couleur locale"

The cover name "Geraet" (equipment) has been translated as "missile".

F.R.-Wagen (Fern Raketen Wagen) (the Meillerwagen) is translated as "missile trailer".

The original document was supplied by Bert Koopman.



## **Control of the A4 rocket.**

The A4 was meant to hit a target. Therefore the impact of the rocket should be as close to the target as possible. That might be achieved by a control system that knows both rocket and target position. The target position may be known with a certain amount of accuracy, in the mid 40's the rocket position was hard to find. Radar- and radio-location hardly existed, GPS was not even dreamt of and dead reckoning requires sensors and computing power beyond the technical abilities of those years. Astro-navigation and terrain-following were no options either, so there was only one solution left: no position control at all.

The Germans gave the missile a calculated speed and direction and hoped for the best. After a minute of flight the rocket engine was cut and all correction became impossible anyway, and the missile had no means to measure side-acceleration. A stable platform allowing such, was under development, but did not arrive in time to play a role in the war. Attempts were made to fill the gap for at least one axis by means of a Leitstrahl system. Leitstrahl was based upon the old Lorentz blind approach system. Airfields generally fulfilled the environmental requirements to the system, like flatness, absence of clutter etc., but for military deployment the system was hardly fit.

The V2 had to do the job with a simple attitude control system, required anyway to keep the missile balanced during the first, slow, part of its trajectory.

### **Attitude stabilization**

There are various ways to keep the nose of a missile forward during flight. The three best known are:

- Rotation. The missile rotates with high speed around its length axis and works like a gyroscope. The usual way to stabilize shells and bullets.
- Arrow shape. The shape is such that the main forces of air friction work on an area lying behind the centre of gravity of the missile. Usually this is achieved with fins at the rear side. Well known applications: arrows, darts, bombs and rockets. It's disadvantage: it only works at considerable speed.
- Counter steering. During WWII only used on some missiles like V1 and V2. Well known from wheeled vehicles (human), aircraft and ships (human and automatic, autopilot).

Attitude stabilization is intended to keep one axis (or more!) of the missile in the same direction. In case of the A4 the pitch- yaw- and roll-axis is stabilized. Pitch and yaw to prevent the missile from toppling over during the slow first part of its trajectory and roll because the direction of the shot is defined by the orientation of the missile before launch. Additionally the yaw-stabilization is used after the vertical part of the trajectory to add to directional accuracy, sometimes assisted by the Leitstrahl guidance plane. The pitch stabilization is also used to steer the missile into its 45° trajectory, after the vertical start.

### **Reasons for unwanted rotations.**

Unwanted rotations of an axis may occur for a number of reasons:

- Wind. Due to the arrow-stabilization of the A4 the wind-force attacks way below the C.O.G., so wind will cause the nose to turn into the direction where the wind comes from.
- Other external reasons like bird-hits, showers etc.
- Differences in air friction on opposite sides of the missile. (Ice!)
- Errors in fin positions, in general: aero dynamical asymmetry of the construction.
- Thrust vector not going exactly through the centre of gravity.
- Changes in C.O.G.

The correction of constant errors, caused by construction or production flaws, is called "trimming".

### The stabilization system

Generally a stabilization system consists of three elements:

- One or more sensors, objects measuring the difference between the ideal and the actual situation.
- Some form of processing unit to translate the sensor signals into a usable form.
- One or more actuators to counteract the error, measured by the sensor.

### Sensors

In the A4 the difference between the ideal attitude and the actual attitude is measured by gyroscopes. A gyroscope is a very fast rotating body with a high moment of inertia, suspended in a system of cardanic rings, allowing it freedom of rotation in every direction. If the gyro is running, it maintains its attitude in space and the rocket, if it rotates, rotates around it.

The difference between the rocket attitude and the gyro attitude is measured by means of a potentiometer. The house of the potentiometer is attached to the rocket body, the shaft to the gyroscope (or v.v.) in such a way that the potentiometer gives 0 V at zero error, a positive voltage if the error is positive and a negative voltage if the error is negative. The voltage is proportional to the magnitude of the error.

One gyroscope is used to measure both roll and yaw, a second gyro measures pitch.

### Processing

Let's assume that the gyro pot gives a voltage, indicating that the missile has turned to the right.

*Angle correction:* the gyro signal is amplified and used to counteract the error. The control steers to the left and accelerates the rocket to the left. At zero degrees error the control current is zero, but the angular speed of the rocket isn't, so it overshoots the zero degrees position to the left. Now the control measures a new error and corrects to the right. The missile decelerates and accelerates to the right. At zero degrees error the control current is zero, but the angular speed of the rocket isn't, so it overshoots the zero degrees line to the right. The rocket oscillates forever.

One thing is clear by now, as every car-driver knew already: the direction of steering has to be reversed before the zero degrees position is reached.

But how???

Obviously the rocket goes into a sinusoidal oscillation if this type of control is used.

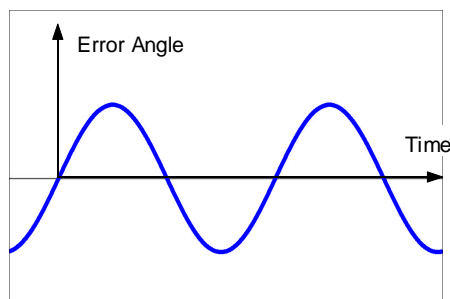

The figure shows that at the moment of zero error angle the angular speed is maximum. The curve is at its steepest point at the zero degrees line, so the change of angle, in other words: the angular speed, is high.

$\alpha$  (Alpha) is the usual symbol for an angle,  $\omega$  (Omega) is the usual symbol for angular speed (degrees or radians per second) and  $\epsilon$  (Epsilon) is the symbol for angular acceleration.

The angular speed of the rocket,  $\omega$ , is the change in angle per time interval.  $\omega = \frac{\Delta\alpha}{\Delta t}$ .

If  $\Delta\alpha$  and  $\Delta t$  are infinitely small, this equation is written as:  $\omega = \frac{d\alpha}{dt}$ . This way of calculating

is called "differentiating" and  $\omega$  is called the "derivative" of  $\alpha$ . The terms are only explained here because they are used in a lot of V2-related documents.

We may calculate  $\omega$  now for every value of  $\alpha$  and plot the results in the same graph.

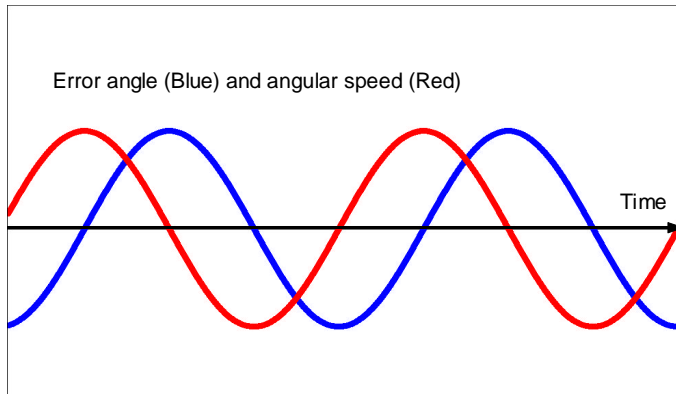

That results into the red curve. Observe that the red curve (angular speed) is highest where the blue curve (angle) is steepest!

But the most important thing: the red curve is shifted to the left with respect to the blue one: **the red one is earlier!!!**

If we could add the speed to the error angle, in controlling the rudders, we could counter-

steer **before** the rocket crosses the zero degree line, and avoid oscillation!

Computing the speed from the angle-variation is possible and theoretically this could result in a stable control system, if some requirements are fulfilled. The most important requirement: rudder actuators, reacting fast and without delay.

Fast reacting rudder actuators are powerful, and that means: heavy, and they need a lot of power. Heavy rudder actuators plus a heavy power supply is not exactly what the average rocket builder is waiting for, and lightweight Luftwaffe (aircraft-) rudder actuators were ready and available, but ..... low powered and slow.

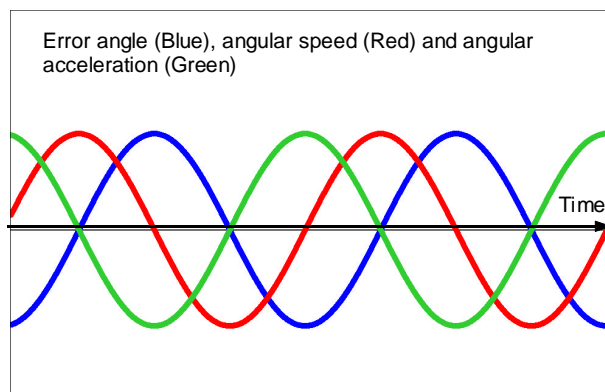

There is only one way to solve that problem: start counter-steering still earlier!

The angular acceleration is maximum where the change in speed is maximum. Let's differentiate the speed and see what happens! The angular

acceleration  $\varepsilon = \frac{d\omega}{dt}$ . The angular

acceleration may be calculated and added to our graph. The result is plotted in green. **And it is earlier**

**again!!!** Speed is earlier than angle and acceleration is earlier than speed. It will not surprise the average car-driver: one has to accelerate before speed is built up and one has to build up speed before a distance may be traveled.

If error angle, angular speed and angular acceleration are combined, it must be possible to design a stable control, even with the Luftwaffe rudder actuators. But where do we get those control signals from? The angle error signal is supplied by the gyro's, but how do we get speed and acceleration?

Tests were performed with a number of mechanical differentiating devices, but none of them succeeded. A mechanical differentiator would have been heavy too, and six were needed, two for every axis, one to obtain the speed by differentiating the angle, the other one to obtain the acceleration by differentiating the speed. Electronics had to solve the problem.

A control signal has to be generated that may be described as follows:

$$S_{control} = f_1\alpha + f_2 \frac{d\alpha}{dt} + f_3 \frac{d^2\alpha}{dt^2} = f_1\alpha + f_2\omega + f_3\varepsilon .$$

The factors  $f_1$  etc. are needed to "tune"

the control to its environment. Parameters like rudder speed and – acceleration, rudder effectiveness, aerodynamic factors, lag, slip, etc. form the basis for these factors. They may differ for every axis!

### The electronic solution

The gyro's supply a voltage, proportional with the error angle  $\alpha$ . To differentiate that value, it is fed into a differentiating network. That sounds complex, but it's just a capacitor in series with a resistor.

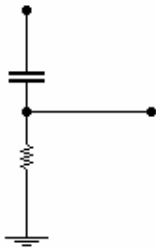

If a constant voltage is connected to the input (topside), no current will flow through the capacitor and consequently no voltage will be measured on the output (right side). If the input voltage goes up, the capacitor charge will increase, so current will flow through the resistor and consequently a voltage will be present at the output. If the input voltage is lowered, the capacitor will discharge and current flows through the resistor in opposite direction. The output voltage goes negative.

The voltage at the output will always be proportional with the *change* of the input voltage, **so the input voltage is differentiated!**

If the input voltage is proportional with the error angle, the output voltage is proportional with the angular speed.

A voltage proportional with the angular acceleration may be obtained by adding a second differentiating network, its input connected to the output of the first one. Like this:

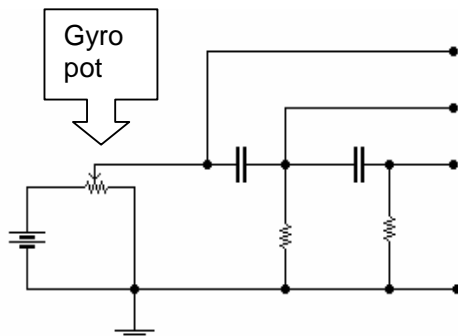

The gyro-pot delivers a voltage, proportional with the error angle and that voltage is differentiated twice. The three output voltages (top to bottom) are proportional with error angle  $\alpha$ , angular speed  $\omega$  and angular acceleration  $\varepsilon$ . The three voltages are added proportionally, amplified and used to drive the rudders.

In the yaw-correction circuit one more voltage may be used to obtain the control-signal, the output of the Leitstrahl receiver. That may look pretty logical at first sight, but it is remarkable that, in a system completely designed to

stabilize the axis system of the rocket, suddenly a signal appears that is not proportional with an angular error of an axis, but represents an offset with respect to the target line. To get a straight flying rocket on the target line again, an angular error must be introduced. That error is counteracted by all the attitude controls involved. In other words: a rocket not flying in the target direction, has a gyro indicating zero error, but the Leitstrahl control voltage forces the rocket in a different direction, the proper one. The attitude of the gyro is not corrected, so the rocket must find a balance between the attitude control, steering right, and the Leitstrahl component, steering left. That is only possible if a Leitstrahl error exists, otherwise the Leitstrahl output would be zero. That means that the rocket constantly flies on the right side of the Leitstrahl plane, otherwise there would not be a Leitstrahl output to counteract the (wrong) gyro-course.

It's not a significant contribution to overall missile inaccuracy, it merely adds an additional parallax, but it illustrates nicely the rather opportunistic way of thinking of the designers.

So that little circuit diagram above is the complete "analog computer" all the V2-freaks are always talking about? Yes Sir! After the signals are added in a small resistor circuit, the control signal is "chopped" by a ring-modulator because amplification of slow DC-like signals in a vacuum-tube amplifier is difficult, than it is amplified and "dechopped", to be fed to the control actuators. The intelligent part of the "Mischgeraet" consists of just two capacitors and two resistors per axis. The whole complex rest is just three amplifiers and a power supply.

Disappointed? Well, I'm one of those V2-freaks myself and I'm not! It's just fun to find out how those things worked, because their unimaginable simplicity is such a contrast with the complexity we are used to in our 21<sup>st</sup> century. That brings us to another amazing concept:

### The Umlenk program.

The acceleration of the A4 after launch was very slow. So slow, that the rocket had to start vertically and gain some speed before it could be tilted into the target direction. At an altitude of about 400 m an ingenious device began to cheat the stabilization system.

If the output of the pitch-gyro is 0 Volts, the rocket obviously has the proper attitude. If the output is not 0 Volts, there must be an error and the control system corrects it until the output is 0 Volts again. So if the nose of the rocket must be turned from a 90° to a 45° elevation, just let it think that it's elevation angle is 45° wrong! How??

Just by turning the house of its potentiometer over 45°. Then the rocket will correct its attitude until the error voltage is 0 again. But you must do it slowly, otherwise all relevant rudders run into their end-stop and there is no control left. A washing machine type program switch switched on a small motor that, over a hi-ratio transmission gear, started to turn the potentiometer housing of the pitch-gyro. It even used different series-resistors to control the rocket turning speed during different sections of the total curve.

As the potentiometers were intended to be used around 0° only, their total range covered minus 20° to plus 20°, another reason to program the Umlenkung in slow and easy steps.

The final elevation angle of the missile at Brennschluss was 43° or 49°, obviously dependent from the version. (In ballistics the maximum range is obtained at an elevation angle of 45°, an *increase* of elevation with  $n^\circ$  causes the same decrease in range as a  $n^\circ$  *decrease* of elevation angle. (In vacuum!) I don't know the reason the Germans used a higher or a lower elevation.)

To obtain an elevation angle of 43°, the rocket has to turn from 90° to 43°, an angle of 47°. The Umlenk program for that situation was as follows:

Time (Sec)	Angular Velocity (°/Sec)
4	0
7	1.8
3	1.2
16	0.9
18	0.8
4	0.5

The program takes the first 52 seconds of flight time. Brennschluss for a 150 km range shot takes place approx. 57.5 seconds after launch and for 280 km range approx. 64.1 sec. after launch, so at the moment of Brennschluss the missile has its proper and stable elevation in all cases.

## Trimming

The pitch and yaw corrections were designed to stabilize the missile, if we forget about the intentional introduction of errors (Umlenk and Leitstrahl) for a moment. Steering around the proper axis results in an average rudder deflection of  $0^\circ$ .

Roll was not caused by *temporary* influences like wind, but by flaws in the rocket geometry, a *constant* error source. (Generally caused by the fins.)

At first roll is counteracted by air- and jet-rudders 1 and 3, deflecting in opposite directions. Rudders 1 and 3 are mechanically coupled with two potentiometers. If rudders 1 and 3 show an equal deflection in the same direction, the output voltage of both pots is identical, so the difference is 0V. In case of roll correction however, the deflections of 1 and 3 are opposite and there is a difference between the output voltages of their potentiometers. The polarity of that voltage difference is, of course, dependent from the roll direction.

If the deflection difference between rudders 1 and 3 exceeds  $3^\circ$ , a polar relay is actuated by the voltage difference and it switches on the trim motors driving the air rudders 2 and 4. Air rudders 2 and 4 assist in controlling the roll and take over more and more of that function, until rudders 1 and 3 are in their parallel position again. The trim-motors driving air rudders 2 and 4 are switched off and the rudders maintain their deflection.

Application of a constant correction against the constant influence of a production flaw is called "trimming" in aviation. For that reason air-rudders 2 and 4 are called "Trimmsegel" or trimming rudders.

Air rudders 2 and 4 were returned to their parallel position after Brennschluss. The risk of the tail breaking up due to aerodynamic forces on re-entry was estimated higher than the risk of a fast rotating missile.

Summarizing: The V2 has three independently working stabilization systems:

- Yaw
- Pitch
- Roll

For every axis the attitude sensor is a gyroscope.

For every axis the angular error signal is processed by differentiating twice and adding the results to the original error. The resulting error signal is amplified and used to control the proper rudders.

The yaw stabilization is "misused" by introducing an "alien" error-signal: Leitstrahl.

The pitch stabilization is "misused" by introducing an "alien" error-signal: Umlenkung.

The roll stabilization uses primarily the 1-3 rudder pair until its constant correction function, "trimming", is permanently taken over by air rudders 2 and 4.

"Programming" the gyro's for required values of axis attitude is performed by setting each axis manually by manipulating the whole rocket before starting the gyro's. This is done by rotating the rocket until fin 1 points into the (virtual) target direction and setting the roll axis plumb by optical means.

Seen through 21<sup>st</sup> century eyes the whole concept was of a breathtaking simplicity and totally unfit for any military use. But maybe the same can be said about the first tank, the first cannon or the first submarine.....